



Staff User's Guide – Integrated ILL

Version 22

CONFIDENTIAL INFORMATION

The information herein is the property of Ex Libris Ltd. or its affiliates and any misuse or abuse will result in economic loss. DO NOT COPY UNLESS YOU HAVE BEEN GIVEN SPECIFIC WRITTEN AUTHORIZATION FROM EX LIBRIS LTD.

This document is provided for limited and restricted purposes in accordance with a binding contract with Ex Libris Ltd. or an affiliate. The information herein includes trade secrets and is confidential.

DISCLAIMER

The information in this document will be subject to periodic change and updating. Please confirm that you have the most current documentation. There are no warranties of any kind, express or implied, provided in this documentation, other than those expressly agreed upon in the applicable Ex Libris contract. This information is provided AS IS. Unless otherwise agreed, Ex Libris shall not be liable for any damages for use of this document, including, without limitation, consequential, punitive, indirect or direct damages.

Any references in this document to third-party material (including third-party Web sites) are provided for convenience only and do not in any manner serve as an endorsement of that third-party material or those Web sites. The third-party materials are not part of the materials for this Ex Libris product and Ex Libris has no liability for such materials.

TRADEMARKS

"Ex Libris," the Ex Libris bridge, Primo, Aleph, Alephino, Voyager, SFX, MetaLib, Verde, DigiTool, Preservation, URM, Voyager, ENCompass, Endeavor eZConnect, WebVoyage, Citation Server, LinkFinder and LinkFinder Plus, and other marks are trademarks or registered trademarks of Ex Libris Ltd. or its affiliates.

The absence of a name or logo in this list does not constitute a waiver of any and all intellectual property rights that Ex Libris Ltd. or its affiliates have established in any of its products, features, or service names or logos.

Trademarks of various third-party products, which may include the following, are referenced in this documentation. Ex Libris does not claim any rights in these trademarks. Use of these marks does not imply endorsement by Ex Libris of these third-party products, or endorsement by these third parties of Ex Libris products.

Oracle is a registered trademark of Oracle Corporation.

UNIX is a registered trademark in the United States and other countries, licensed exclusively through X/Open Company Ltd.

Microsoft, the Microsoft logo, MS, MS-DOS, Microsoft PowerPoint, Visual Basic, Visual C++, Win32, Microsoft Windows, the Windows logo, Microsoft Notepad, Microsoft Windows Explorer, Microsoft Internet Explorer, and Windows NT are registered trademarks and ActiveX is a trademark of the Microsoft Corporation in the United States and/or other countries.

Unicode and the Unicode logo are registered trademarks of Unicode, Inc.

Google is a registered trademark of Google, Inc.

Copyright Ex Libris Limited, 2014. All rights reserved.

Document released: January 13, 2014

Web address: <http://www.exlibrisgroup.com>

Table of Contents

1	OVERVIEW.....	6
1.1	List of important terms.....	7
1.2	The Integrated ILL GUI desktop	10
1.2.1	Screen elements.....	10
1.3	Workflows.....	14
2	SETTING UP INTEGRATED ILL	17
2.1	Setting up ILL partners	17
2.1.1	Creating partners	19
2.1.2	Creating patron records for ILL partners	21
2.2	Creating an authorized staff user	22
2.3	Configuring a roster of potential suppliers (for borrowing requests)	23
2.4	Assigning ILL units to library patrons	27
3	BORROWING REQUESTS.....	28
3.1	Creating ILL borrowing requests	29
3.2	Handling New Borrowing Requests	32
3.2.1	Locating possible suppliers	34
3.2.2	Assigning potential suppliers	36
3.3	Following up borrowing requests	37
3.3.1	Viewing borrowing requests' statuses.....	38
3.3.2	Handling messages in the Messages node.....	40
3.3.3	Available borrowing-related batch services / reports	42
3.4	Receiving material from suppliers	42
3.5	Renewing Material on Loan.....	46
3.5.1	Sending a Renew Request	46
3.5.2	Renew Accepted	46
3.6	Renewing and Recalling Material on Loan to Patrons via GUI-Circ	47
3.7	Returning material to suppliers	49
3.8	Other Borrowing Request Activities.....	51
3.8.1	Corresponding with the Supplier.....	51
3.8.2	Copyright	52
3.9	Sending Borrowing Requests to OCLC using Direct-to-Review	54
3.9.1	Defining OCLC Direct Supplier	54
3.9.2	Workflow for Borrowing Requests when Supplier is OCLC Direct.....	55

4	LENDING REQUESTS	56
4.1	Creating an ILL Lending Request.....	56
4.2	Handling new lending requests	60
4.2.1	Locating new requests	62
4.2.2	Identifying a requested item (optional)	64
4.2.3	Printing call slips.....	65
4.2.4	Sending a response	65
4.2.5	Reporting that material cannot be supplied	67
4.2.6	Referring a request to another supplier	69
4.2.7	Shipping material	70
4.2.8	Requests – optional actions – printing, deleting, changing statuses.....	72
4.3	Following up lending requests	72
4.3.1	Handling messages in the Messages node.....	72
4.3.2	Viewing lending requests’ statuses	75
4.3.3	Running the overdue loans services / reports	76
4.4	Checking in returnable material.....	76
5	THE ILL REQUEST LOG	78
6	ILL HISTORY PROCEDURE.....	78
7	GUI ILL SERVICES.....	80
7.1	Borrowing Services.....	80
7.1.1	Borrowing Library Statistic Report (ill-63).....	80
7.1.2	ILL Request Report (ill-74).....	81
7.1.3	Static Status Requests Report (ill-66)	81
7.1.4	Outstanding Requests of Former Patrons (ill-67).....	81
7.1.5	Claim Report and Letters (ill-73).....	81
7.1.6	Send Requests to the British Library (ill-75)	81
7.1.7	ILL - Hold Shelf List (ill-76)	82
7.1.8	Send Requests to a supplier service (ill-10)	82
7.2	Lending Services.....	82
7.2.1	Lending Library Statistic Report (ill-64).....	82
7.2.2	Overdue Handling (ill-68).....	83
7.2.3	Expired Messages (ill-69) – For ISO-ILL only	83
7.2.4	Lending Library - ILL Requests Report and Slips (ill-65).....	84
7.3	US Copyright Services.....	84
7.3.1	Copyright Payment Report (ill-61)	84
7.3.2	Copyright Statistics Report (ill-62)	84
7.4	Archiving Services.....	84
7.4.1	Generate Borrowing History (ill-88).....	84
7.4.2	Generate Lending History (ill-89).....	85
7.4.3	Archive ILLSV Documents (ill-72)	85
7.4.4	Patron Link Removal (ill-70)	85
7.5	General Services	86
7.5.1	Build Word Indexes for a Record (manage-111)	86
7.5.2	Synchronize patrons’ data with ILL partners’ data (ill-77).....	86

7.5.3	Load Potential Supplier Default (ill-52).....	86
APPENDIX A	87
	Borrowing Request Statuses that have a Corresponding ISO/ILL Protocol State	87
APPENDIX B	90
	Lending library request statuses	90

1 Overview

The Integrated ILL module is used to manage

- Your library patrons' ILL procurement requests
- Requests directed to your library by other libraries to supply material through ILL
- The administrative records that are required to support the above two services

The ILL records are contained within an ALEPH® library of the ILL type (for example, 'USM40', 'XXX40'). Each ILL library is related to a single ADM library (for example, 'USM50', 'XXX50'), and vice-versa.

The Integrated ILL records and procedures involve two-way traffic:

- Requests by patrons to procure material
- Requests directed to the library to supply material

There are a number of ways in which your system librarian can customize your Integrated ILL system regarding:

- The method of communication with ILL partners – mail, e-mail, ISO or SLNP protocols
- The degree to which the system does unmediated handling of both lending and borrowing requests

There are two types of records that must be in place before you can begin to work with Integrated ILL: Partners and Roster of potential Suppliers.

- Partners – External and Internal
 - External Partners – the external organizations to which you direct your requests, and from whom you receive requests
 - Internal Partners (ILL Units) – the organizations (administrative units within the ADM libraries in your ALEPH installation) that handle ILL requests (both borrowing (patron requests) and lending (requests from other libraries)). The ILL Unit functions in a manner similar to a sublibrary, and several sublibraries can be grouped into a single ILL Unit. A specific ILL Unit, set in the Global Patron Record, handles the patron's requests.
- Roster of potential suppliers that is used to assign the suppliers to which a borrowing (outgoing) request will be sent. For SLNP, this is not necessary as the potential suppliers are identified by the ZFL server.

There are two types of requests (two request forms), in both the GUI and in the Web OPAC:

- Monograph
- Serial

1.1 List of important terms

Borrowing

Borrowing refers to the activity of requesting material from another library; although the word “borrow” implies a circulation checkout transaction, the library might send you a copy, which need not be returned (non-returnable).

Borrowing request

A borrowing request is also known as an outgoing request. A Borrowing request is sent by an ILL unit to a potential supplier, in order to fulfill a patron’s request for material.

The following list of actions outlines the steps for a borrowing request. Steps marked with an asterisk (*) can be set to unmediated; steps marked with two asterisks (**) can be unmediated only if communication is through ISO ILL.

1. Create request (created by patron in the OPAC, or by staff in Integrated ILL module)
2. * Check whether requested material is locally owned (when a request is placed by the patron in the OPAC, the request can be blocked if it is locally owned)
3. * Assign potential suppliers to the request
4. * Send the request to the potential supplier
5. ** Register supplier response (if communication is through ISO, this will be unmediated)
6. Register receipt of the material
7. If material received is a returnable item, return the material

Bulk handling

The Integrated ILL GUI includes “bulk” processing for material dispatch and receipt, based on reporting a barcode and/or request number.

Communication

You can communicate with ILL Partners in different ways:

- Print (Mail/fax)
- E-mail
- ISO ILL 10160/10161 protocol
- SLNP (Simple Library Network Protocol, used in Germany)

Incoming request

An incoming request is received from an ILL partner, requesting that you supply material. An incoming request is also called a lending request.

Lending

Lending refers to the activity of supplying material to another library; although the word “lend” implies a circulation checkout transaction, you can send material as a non-returnable copy.

Lending request

A lending request is also known as an incoming request.

The following list of actions outlines the steps for a lending request. Steps marked with an asterisk (*) can be set to unmediated; steps marked with two asterisks (**) can be unmediated only if communication is through ISO ILL.

1. ** Create request (if communication is through ISO, this can only be unmediated)
2. * Search to verify if the library has the requested material
3. ** Send response to requester if the material is not available in your library
4. Send response other than “unfilled” (not available)
5. Register shipment of the material
6. If material shipped is a returnable item, return the material

Locally-owned

A “locally owned” check can be made when a borrowing request is initially created by staff user via GUI ILL or by the patron via the Web OPAC. This can be set as part of the unmediated processing. It can be set so that patrons cannot place requests for locally owned material.

Mediation

ILL requests (borrowing and lending) can be processed as mediated or unmediated as desired, within the constraints relating to how the ILL unit communicates with an ILL partner. All processing, apart from the physical actions of fetching and sending material, and receiving and returning material, can be unmediated. For partners with whom ISO communication is the standard, message handling can also be unmediated, whereas for non-ISO ILL partners, message handling must be manual.

Partners

An ILL partner is an administrative unit that sends requests to you, and/or that responds to your requests for material. Each library/institution that is used as a player (requester or supplier) in the ILL flow, including your own administrative unit, has a partner record in the system.

There are three types of partners: Internal ILL unit, external shared and external non-shared.

- **Internal Partner – also known as ILL Unit: local administrative unit that** handles the ILL borrowing and lending activities. A unit can be set up

to represent a single sublibrary, or a group of sublibraries. The unit fulfills two **types of services**:

- ILL-UNIT for outgoing requests (borrowing library) - handles the ILL requests for a group of patrons; each patron is handled by a default unit defined in that patron's global information record.
- ILL-UNIT for incoming requests (lending library) - an administrative unit that handles the ILL requests directed to it; it is authorized to lend items from specific sublibraries.
- **Shared External Partner**- a supplier or a requester library which is not a part of any ADM library of your library system; it is external to your **library system (for example, another library or a supplier like BLDSC)**. An external shared partner can be used as a supplier by all ADM libraries.
- **Non-shared External Partner** - a non-shared external partner is the same as a shared external partner, but it can be used as a supplier only by the library which created the partner record.

Each ILL partner (both external and internal) to whom you supply ILL material must have a parallel Patron record.

Patrons

Two types of patrons are part of the Integrated ILL setup:

- Library patrons who are served by ILL. They are allowed to submit ILL requests on their own. The Global Patron record includes the assignment of the ILL Unit that will handle his/her requests, a limit of the number of total requests and a limit of the number of active requests allowed for the patron. All ILL-related circulation activities are registered on the patron record: loans; renewals; returns; and so on.
- ILL partners to whom you supply material (external partners and internal ILL units)

Roster

The Potential Suppliers List sets the roster of ILL partners to which an outgoing (borrowing) request is directed. The potential suppliers list is built for each requesting Unit and material type. The list is consulted by the system when a borrowing request is processed.

Staff users

ILL staff users are charged with setting up administrative records (suppliers, units, rosters, patrons,), processing outgoing ILL requests and handling incoming requests received from other libraries. Each staff user is allowed to access and perform actions in a single ILL Unit. ILL users must be empowered the ILL module, and for required Circulation processes.

1.2 The Integrated ILL GUI desktop

The Integrated ILL GUI has been designed with an emphasis on workflows.

- Requests are listed in status groups, for online identification of requests that require processing.
- Actions can be carried out by choosing the action (Ship, Receive, Return, and so on) and entering an identifier (barcode or request number), rather than having to access the record and perform the action. This is similar to Loan and Return functions in Circulation, as compared with Order functions in Acquisitions.

Here is an example of an Integrated ILL GUI Borrowing Tab screen, in Functional mode. It displays a list of borrowing requests that are waiting to be processed:

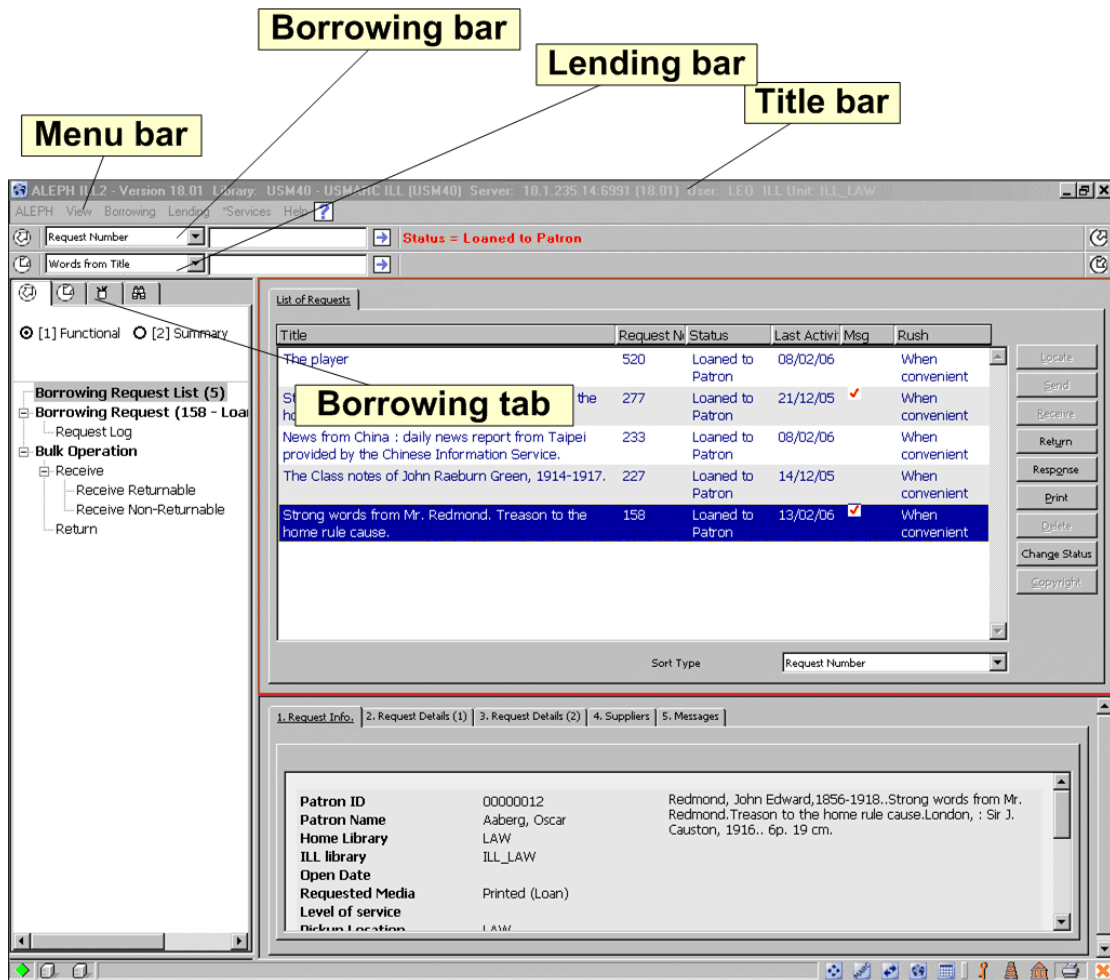

1.2.1 Screen elements

Title bar

The title bar shows the name of the program. It also displays status messages relating to the client-server connection:



Menu bar

The Menu bar contains first-level actions, from which second-level menus are accessed.

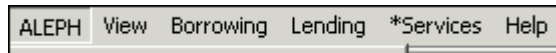

Borrowing bar

The Borrowing bar is used to retrieve borrowing (outgoing) requests; request number, patron ID, words from title, supplier code, and so on, can be used for searching. All matching requests display in a list.



Lending bar

The Lending bar is used to retrieve Lending (incoming) requests; request number, barcode of the supplied copy, words from title, requester code, and so on can be used for searching. All matching requests display in a list.



New request

At the far right side of the Borrowing and Lending bars, there are buttons that serve as shortcuts for creating new borrowing and lending requests for serial and non-serial format.



Borrowing and Lending Tabs

The Borrowing and Lending tabs are used for viewing and handling outgoing and incoming requests. Each tab has two modes of display, Functional and Summary.

- Functional mode
- Summary mode

In the Functional display, actions can be carried out, and records can be updated.

The Summary mode gives an overview, a “table of contents” of the requests (by request status), and of the messages (by message type). This view serves as an index to the requests, displaying the number of requests per status, and with the ability to select a group of requests for Functional display and action. Not all statuses require action, some display for informative purposes only. The text of statuses that require operator action displays in bold. You can limit the display to list only statuses that currently have requests. To do so, select the **View Active St.** check box.

The nodes in the Summary view of the Navigation Tree are Statuses and Messages:

- **Statuses**

The Statuses node is organized into sub-nodes, similar to folders, with “main” statuses and “sub-statuses”. Click the plus sign to the left of a status in order to open sub-statuses display. Click the minus sign to the left of a status in order to close sub-statuses display. At the right of each status, a number in parentheses shows the count of the requests that currently share this status. Highlight a status or sub-status in order to display a summary count in the right pane, and, from there, to select a group of requests for display in Functional mode.

- **Messages**

The Messages node is relevant for is relevant only for sites that implement ISO ILL for communicating with partners. This branch appearance is depended on a system flag. The Messages node is organized into sub-nodes of different message types. At the right of each message type, a number in parentheses shows the count of the requests that have received such a message, where the message has not yet been “dismissed” (that is, reviewed and acknowledged).

Select a message sub-node in order to display and handle the messages in the right pane.

Following are examples of the Lending tab, in Summary and Functional mode:

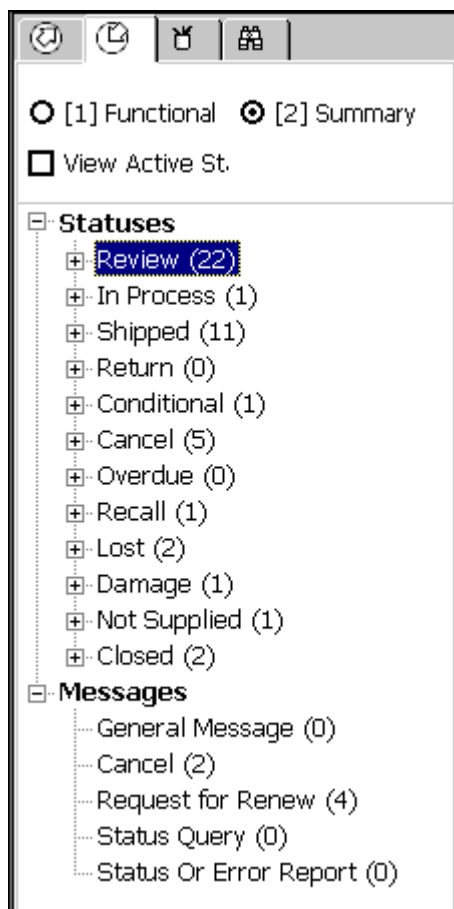

Summary mode – All

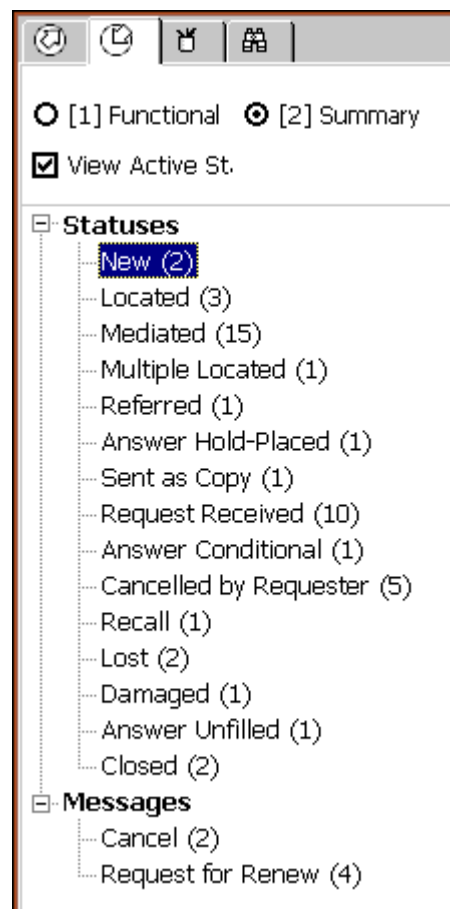

Summary mode - Active

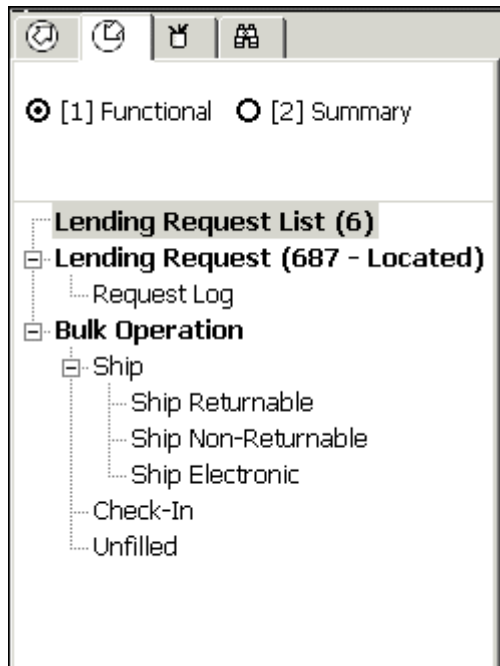

Functional mode

Administration tab

The Administration tab is used to view and handle:

- Partners -Registration of ILL ‘partners’ (requesters and suppliers), both internal partners (also called ILL Units) and external partners.
- Potential Suppliers - Configuration of the supplier rosters, to whom requests will be sent.
- ISO APDU Exceptions - This is relevant only for sites that implement ISO ILL for communicating with partners. This branch appearance is depended on a system flag. The list enables you to manage ISO messages that were not processed and therefore were not integrated with the ILL data.

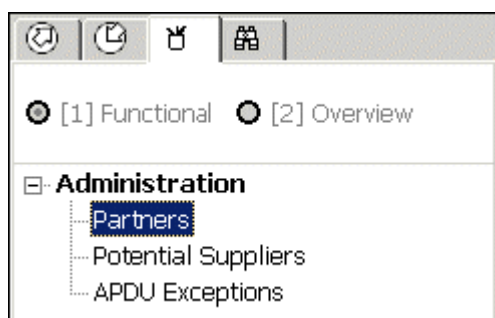

Search tab

The Search tab is used to search and retrieve bibliographic records from local and remote databases. You can use the search to

- Check the local bibliographic database, view local holdings and circulation status
- Search for a work in another library

- Create a request (borrowing or lending); bibliographic details are automatically copied from the retrieved record
- Search for an ILL request (borrowing or lending)

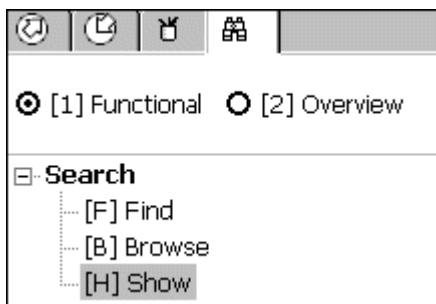

1.3 Workflows

There are two different types of tasks when working with the Integrated ILL module:

- Setup (managing partners and potential supply rosters)
- Handling of borrowing and lending requests

The setup tasks must be performed before working with the Integrated ILL module. After the setup stage, these tasks will be performed only when required, and not on a daily basis. Setup tasks are explained in [2 Setting up Integrated ILL](#) on page [17](#).

Handling of borrowing and lending requests is performed by ILL staff on a day-to-day basis. Each request has a life cycle, from the point at which it is created, until the point at which it is closed. All requests between these two points in time are active requests.

Borrowing Request Life Cycle

This is a schematic outline of the Borrowing Request cycle; some of the actions are optional; some of the actions can be performed in a manual or automatic manner

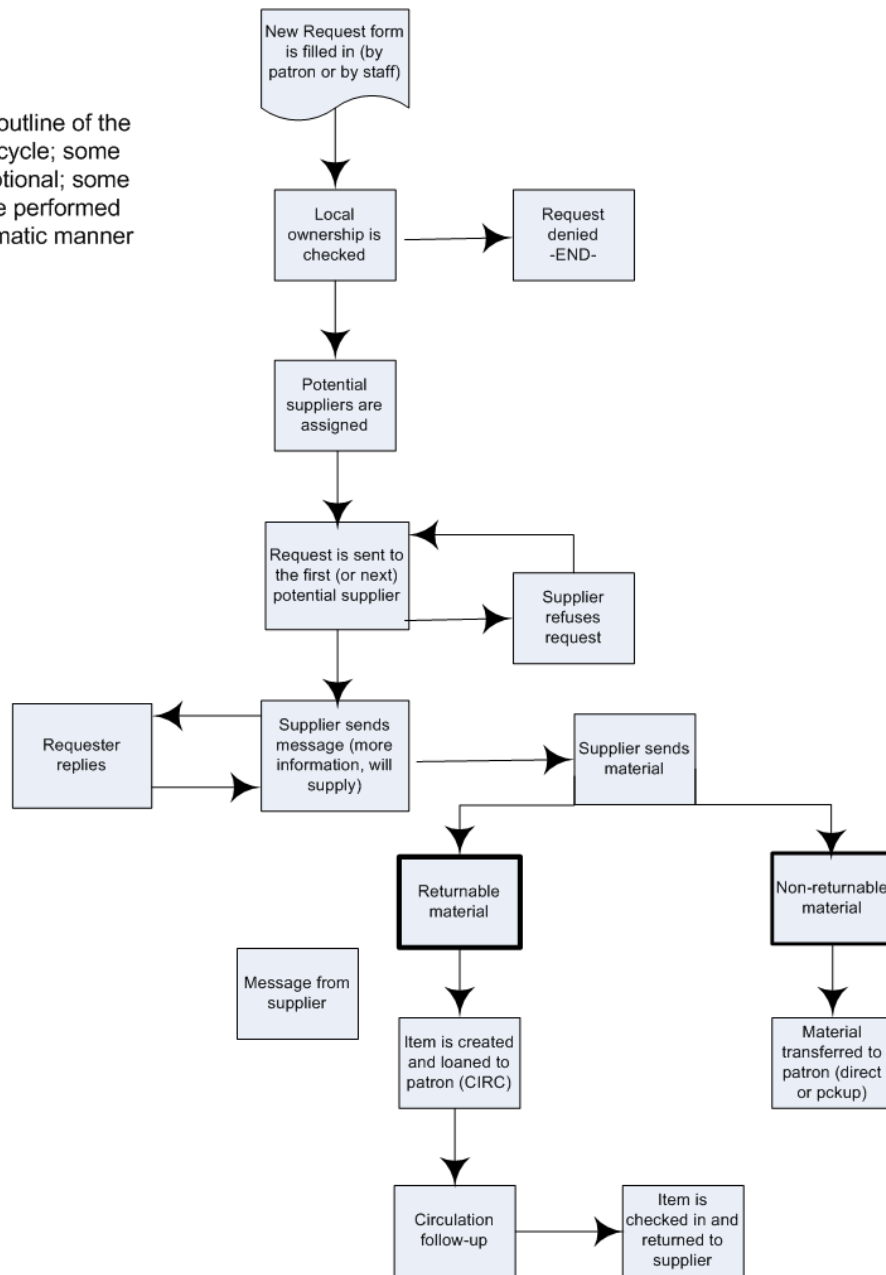

Lending Request Life Cycle

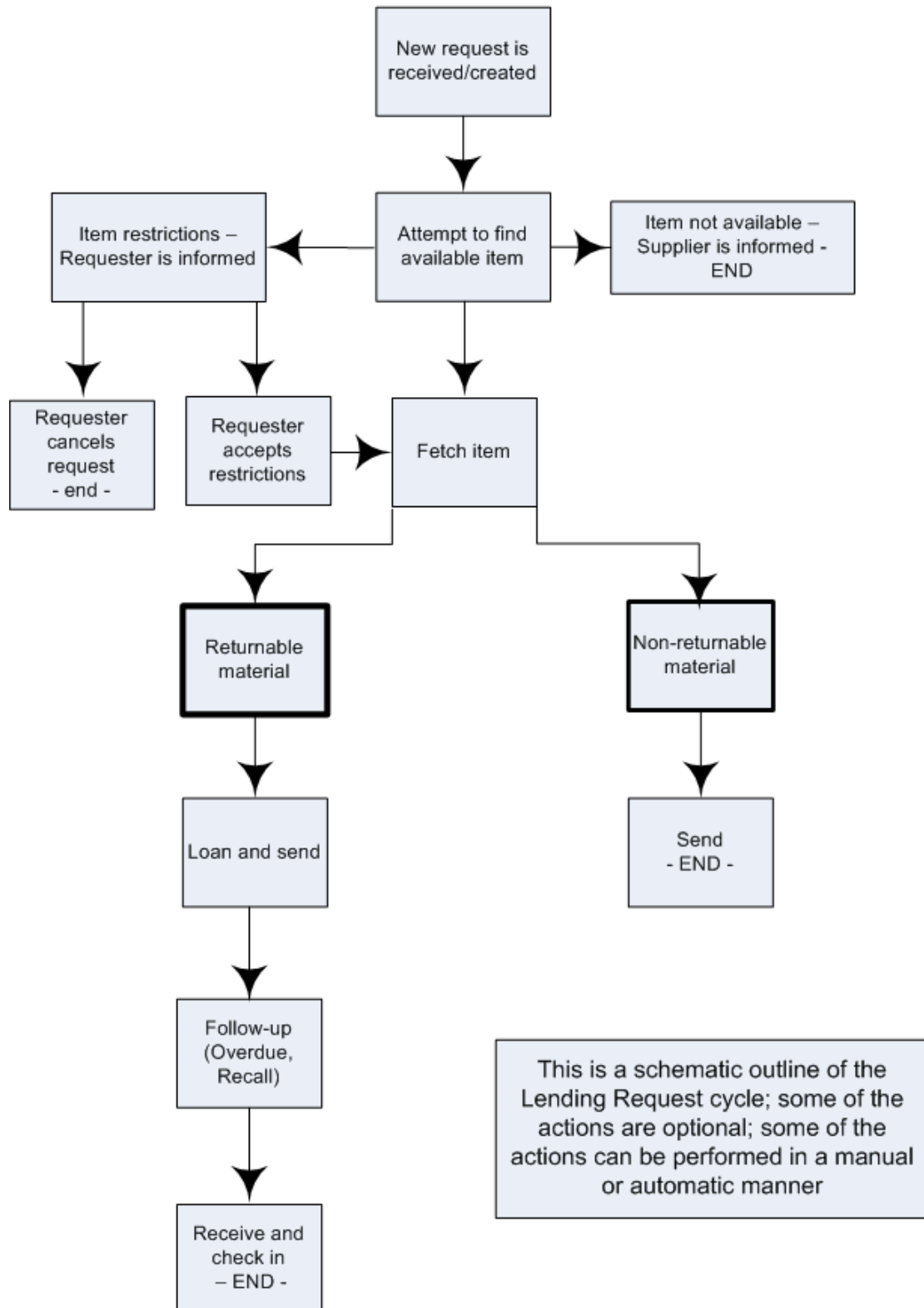

2 Setting up Integrated ILL

In order to begin working with Integrated ILL functions, you must do the following:

1. Set up ILL partners (internal units and external suppliers) and create patron records for them.
2. Create an ALEPH user who is authorized to work with ILL and relevant CIRCULATION functions; the user is authorized to perform tasks within the environment of a specific ILL Unit. You will not be able to create an ALEPH user unless ILL units are present in the Integrated ILL system.
3. Create a roster of potential suppliers (for borrowing requests)
4. Assign an ILL unit to library patrons who have ILL privileges

2.1 Setting up ILL partners

Before your library can begin to provide ILL services, the ILL partners (internal units and external suppliers) must be entered in the system. Each ILL partner who requests an item from you, or who responds to your requests for material, must have a partner record in your system. In addition, you yourself are an ILL unit. ILL units must be present in the system in order for an ALEPH user to be created (see section [2.2 Creating an authorized staff user](#) on page 22).

Companion parallel patron records must also be opened for each ILL partner (see [2.1.2 Creating patron records for ILL partners](#) on page 21).

ILL partner records are viewed, created and updated through the Administration/Partner node in the Administration tab of the Integrated ILL module.

The following is an example of the Administration tab:

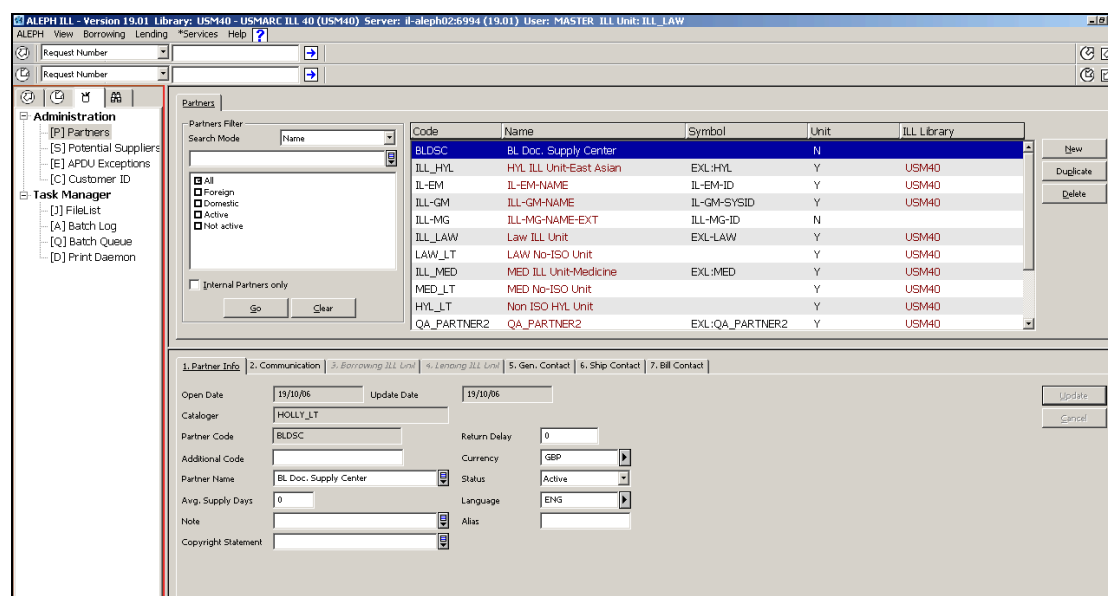

The list of ILL partners (internal ILL units and external suppliers) is displayed in the upper-right pane:

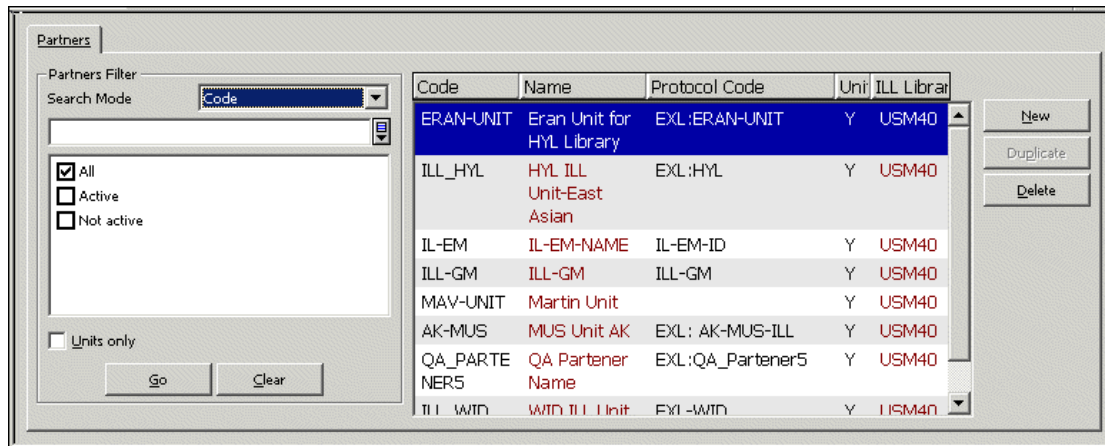

You can use Search mode and the Filter options to sequence and filter the list. You can set the Search mode to Code, Name, Keywords or Exact code.

The **Name** and **Code** Search Mode filters affect the order of the entries in the list (a”b by name or code) to allow you to browse through the list of partners.

When filters are not active, the list includes all internal partners, all external partners that are shared by all units, and all non-shared external partners that can be used by your institution (ADM/ILL library).

<i>To</i>	<i>Do this</i>
Access the list at a particular place in the alphabet, if you know the code	From the Search mode drop-down list, choose Code , type the first few letters of the partner code in the space provided and click Go .
Access the list at a particular place in the alphabet, if you know the partner name	From the Search mode drop-down list, choose Name , type the first few letters of the partner's name in the space provided and click Go .
Retrieve a partner record by code	From the Search mode drop-down list, choose Exact Code , type the code of the partner in the space provided exactly as it was entered into the system and click Go .
Filter the list to include only Active or only Not Active partners	Select the Active/Not Active check boxes as appropriate.
List only internal partners	Select the 'Internal Partners only' check box to list only internal partners.
Clear filters and return to the default All	Click Clear .

2.1.1 Creating partners

When you create a new partner record, you are prompted to choose the partner type. The choices available to you will be different depending on whether you are logged in as an ILL staff user or as an ADM library administrator user (staff ILL unit=ADMIN):

- An ILL staff user may only add External (shared and non-shared) partners.
- An ADM library administrator user (staff ILL Unit=ADMIN) can add, update, and delete, both Internal and External (shared and non-shared) partners.

<i>Partner type</i>	<i>Explanation</i>
Internal Partner (ILL Unit)	An administrative unit that handles ILL activities for a sublibrary or group of sublibraries within a single ADM environment. You can create or update internal partners within your own ADM environment only. This choice is available only if you are logged in with ADMIN as your ILL Unit.

<i>Partner type</i>	<i>Explanation</i>
Shared External Partner	A supplying or requesting library which is not a part of your ALEPH system; it is external to your library system (for example another library or a supplier such as BLDSC). An external shared partner can be used as a supplier/requester by the ILL units of all ADM libraries.
Non-Shared External	A non-shared external partner is the same as a shared external partner, but can be used only by the Units within a single administrative environment (ADM library).

To create a new partner

1. From the Partners List, click **New** or **Duplicate**. The Add Partner dialog box appears:

2. Choose a Partner Type from the available options and click OK. A multi-tab partner record displays in editing mode in the lower pane:

Note

For detailed information about the various tabs and fields, refer to Integrated ILL online Help.

<i>To</i>	<i>Do this</i>
Update a partner	In the Partners list, select a partner. The appropriate partner record displays in the lower pane in editing mode.
Delete a partner	In the Partners list, select a partner, and click Delete . When a partner record is active (has linked active requests), it cannot be deleted.
Duplicate a partner	In the Partners list, select a partner, and click Duplicate .

2.1.2 Creating patron records for ILL partners

In order to allow circulation transactions for the ILL partners (loan, return, recall and renew), each ILL partner must have a global and a local patron record in the ALEPH system.

The ILL partners' patron records are viewed, created and updated through the Patron Registration node in the Patron tab of the Circulation module. Section 2 of the Circulation section of the User Guide details how to create and update patron records. Your library will probably set aside a patron status for ILL partners.

To set up a patron record for an ILL partner

In the Circulation GUI interface, create a global patron record for the ILL partner, entering at least the following:

Global Patron Information

- Patron ID: ILL Partner Code
- Name: ILL Partner Name
- Pin Code, Barcode, Barcode Verification and Language (can be system-generated)

For a multi ADM environment that does not use 'User Sharing' mode (i.e. TAB100-USER-SHARING set to "N") the patron record for the ILL partners must be defined in a different way. The library's ADM code has to be added to the Partner code.

For example:

If the ADM library ABC50 is defined as non-shared-users (TAB100-USER-SHARING=N), the patron ID of the ILL partners records must be defined with a prefix of ABC50.

For partner code MEDIL, define a patron record with ID: ABC50-MEDIL (not MEDIL).The **maximum** the partner's code can be 6 is characters long.

If we add the prefix (e.g. ABC50- which is 6 characters long) we have only 6 characters remaining for the patron ID (the maximum length of Z303-ID is 12 characters long).

ALEPH Local Patron Information

- Status: ILL Borrower Status
- Expiry Date: Dec.31, 2099
- Photo Charge: F
- Privileges: irrelevant, but must be set

2.2 Creating an authorized staff user

In order to empower a staff member for working with the Integrated ILL module and processes, the user must be authorized for an ILL Unit, and relevant authorizations must be assigned to the user, through the Staff Privileges interface.

For instructions for creating an ILL ADMIN staff user, see the 'ILL Staff User' chapter in the *System Librarian Guide - Integrated ILL*.

To assign an ILL Unit to a staff user

1. From the status bar, right-click .
2. Click **Staff Privileges**.
3. In the Staff Privileges window, select the appropriate user and click **Modify User**. The User Password Information window opens:

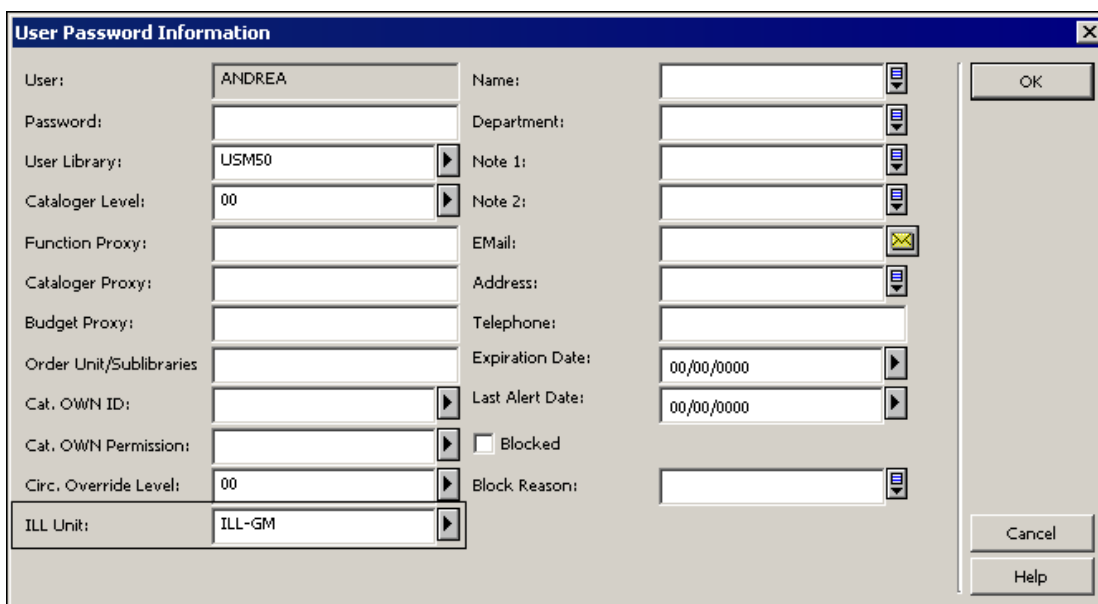

4. In the ILL Unit field, type the appropriate name, for example, *ILL-GM*.

5. Click **OK**.

The user must be assigned ILL privileges in the ILL library (XXX40), patron, circulation and items privileges in the ADM library (XXX50), and in privileges in the password library (pw_library USR00).

2.3 Configuring a roster of potential suppliers (for borrowing requests)

A roster of possible suppliers is used to assign the suppliers to which a borrowing (outgoing) request will be sent. A roster is required for unmediated handling of requests; it is also an aid when mediated handling is performed. Each ILL Unit is responsible for creating its own roster of ILL partners.

The roster comes into play in the following manner – when a borrowing request is processed, the system attempts to ‘locate’ the material on each relevant supplier’s database, and to identify which suppliers from the roster have available items. “Successful” suppliers are assigned to the request. When a supplier is unable to fulfill the request, the request is sent to the next supplier in the list, and so on. The order of the suppliers is determined either by their order in the roster, or by random selection (depending on the profiling of the suppliers in the roster).

In case of SLNP, the potential suppliers are determined by the central ILL server. When a supplier is unable to fulfill the request, the central ILL server sends the request to the next supplier in its list. When communicating via SLNP, it is not necessary to configure a roster of potential suppliers.

The roster can include a “last resort” supplier (group level 99). A request that cannot be fulfilled by any of the other suppliers will be sent to this supplier, without checking for availability.

Each ILL Unit configures its own roster of potential suppliers, for each type of material (for example, serials, audio visual) and for the format in which the material should be supplied (returnable, non-returnable, hard copy, electronic copy, and so on). The material type and the format are defined in the Request Media field.

There is an option for defining potential suppliers for media: Any Media.

When the system attempts to locate potential suppliers for a borrowing request (when **Locate** is clicked or the via the ILL Library daemon), the roster of the request specific media is applied and the roster of Any Media is applied.

For example: When the system attempts to assign a supplier to a borrowing request of media type: Printed (Loan), the rosters that are set to the Printed (Loan) media and ANYMEDIA are applied.

The results of the locate action are based on a cross-analysis of both rosters: Printed (Loan) and ANYMEDIA.

When a supplier is manually added to a request (that is, when **Add Supplier** is clicked), the drop-down list of suppliers contains the specific media's potential suppliers, the ANYMEDIA potential suppliers (if defined), and the NOMEDIA potential suppliers (if defined). However, while the specific media's potential suppliers and the ANYMEDIA potential suppliers are included in the Locate function,

NOMEDIA potential suppliers are NOT included in the Locate action. They can only be added to the potential suppliers list manually.

Features of the roster are:

- Each ILL unit controls its own roster
- Entries in the list can be set for particular types of material (for example, Machine-Readable, Serials)
- Entries in the list can be set for particular methods of supply (for example, electronic, loan, photocopy, electronic copy)
- Each entry (supplier) in the list is profiled for:
- Base which is searched. Note: when adding a new line to the potential supplier list, the system will automatically fill in the supplier's default Locate Base (as defined in the supplier's partner record). In the event that you want the system to use another base (not the one that is defined in the supplier's partner record), select a base from the list.
- Average Supply Days- Number of days it takes for material to be supplied. This parameter and the supplier's non-working days parameter are taken into account by the system when allocating the supplier for a borrowing request.
- Return Delay - How long it takes to return material that has been supplied
- Expiry Days – Relevant only for ISO-ILL. Number of days after which the request expires.
- The roster can contain levels (groups)
- The suppliers within a level can be sequenced, or can be randomized

To display your Unit's Potential Suppliers List, choose the Potential Suppliers node in the Administration tab:

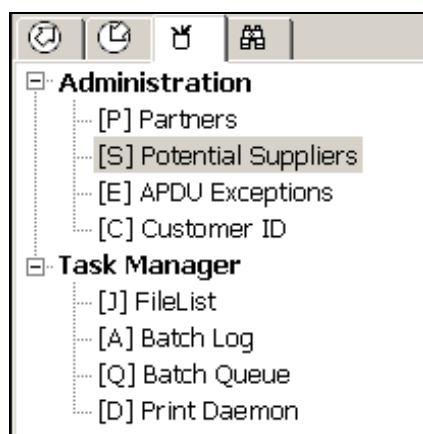

The full list displays in the upper right pane:

Potential Suppliers List

Supplier: [Dropdown]

Media / Level: [Dropdown]

[Go] [Clear]

Rearrange Options

Level: [Dropdown] Sequence: [Dropdown]

[Rearrange]

Request Media	Level	Seq.	Supplier Name	Locate Base	Randomize	Supp.Days
Any media	01	01	ILL-GM	USM01	N	
Any media	01	02	ILL-MG-NAME-EXT	LOC	N	
Any media	01	03	Olomouc Library	VKOL	N	3
Any media	99	01	ILL-MG-NAME-EXT	LOC	N	5
Printed (Loan)	01	01	MUS Unit AK	MUS	N	2
Printed (Loan)	01	02	WID Unit AK	WID	N	2
Printed (Loan)	01	03	LAW Unit AK	LAW	N	2
Printed (Loan)	01	04	ILLGM2	ILLGM2	N	
Printed (Loan)	01	01	MUS Unit AK	MUS	N	2
Printed (Loan)	01	02	LAW Unit AK	LAW	N	2
Printed (Loan)	01	03	MED Unit AK	MED	N	2

[Add] [Delete] [Random I. 1]

The display shows

- Request media – the format in which you want to receive the material
- Level – the group within the media; when choosing a possible supplier, the system goes through each group within the media separately
- Sequence – the order of the suppliers within a level; this is relevant only if the suppliers are not set to “randomized”
- Supplier name
- Locate base – code of the base which will be searched for a matching bibliographic record; that is, on which the ‘locate’ will be performed.
- Randomize – “N” indicates that the suppliers are addressed in the order in which they are listed; “Y” indicates that the suppliers are addressed in random order
- Supply days – the number of days in which material will be received from the supplier.

You can filter the list by filling in one or more of the fields at the left of the Potential Suppliers list:

Potential Suppliers List

Supplier: [Dropdown]

Media / Level: [Dropdown]

[Go] [Clear]

Rearrange Options

Level: [Dropdown] Sequence: [Dropdown]

[Rearrange]

To	Do this
View a list of the potential supplier records for one partner	<p>In the Potential Supplier's list, select a Supplier from the Suppliers drop-down list and click Go (the drop-down list is ordered alphabetically by Partner code).</p> <p>If you want to filter the resulting list further, for example, to see if a potential supplier record exists for the media type Microform (copy), select a media type from the Media/Level drop-down list and click Go.</p>
View a list of all partners with potential supplier records of one particular media type	<p>In the Potential Suppliers list, leave the Supplier drop-down list empty, choose a media type from the Media/Level drop-down list and click Go.</p> <p>This list will show you the order in which the system searches for potential suppliers within a media type.</p> <p>If you want to further limit this list so that you only see the group of potential suppliers for one media type within one specific level, select the level (01, 02 and so on) from the Media/Level drop-down list and click Go.</p>
Start over and perform a different search	<p>In the Potential Suppliers list, click Clear to clear the search filters.</p>
Rearrange the order in which the system sets potential suppliers within a group, or to move a supplier from one group to another	<p>In the Potential Suppliers list, select a potential supplier, choose Level from the Rearrange Supplier section, choose the Sequence number that you wish to assign to the highlighted supplier, and click Rearrange. The potential supplier record will move to the appropriate place in the list.</p>
Randomize the order of the potential suppliers within a level	<p>In the Potential Suppliers list, select one of the lines in the level and click Randomize (if the group of suppliers is already randomized, the button will be labeled De-Randomize, in which case the suppliers will be sequenced).</p>
Add a new potential supplier	<p>In the Potential Suppliers list, Click Add. An empty entry form will open in the lower pane.</p>
View and/or update a potential supplier entry	<p>Select the relevant line in the Potential Suppliers List. The lower pane displays a</p>

To

Do this

tab containing the supplier roster information and another tab with the supplier roster form for updating.

Note

For detailed information about the various tabs and fields, refer to Integrated ILL online Help.

Remove a potential supplier from his place in the roster

In the Potential Suppliers list, select a roster line and click **Delete**. This removes the highlighted roster line; it does not remove all the roster lines of this supplier.

2.4 Assigning ILL units to library patrons

Library patrons who have ILL privileges must have an ILL unit assigned in their Global Patron records. You do this in the Circulation GUI (see section 2 in the *Staff User's Guide – Circulation*) by assigning the ILL Unit that serves the patron, and the request limits – total number of requests allowed within a time period (the time period is set by the library, for example, a year or a semester) and the total number of active requests allowed:

The screenshot shows a web form with two tabs: '1. Global Patron Details' and '2. Global Blocks and Notes'. The 'Global Patron Details' tab is active. The form contains the following fields and values:

Open Date:	23/06/89	Update Date:	02/02/06
Patron ID:	00000012	Pincode:	00000012
Barcode:	B-087274	Barcode Verification:	B-087274
Name:	Aaberg, Oscar		
Salutation:			
Title:		Date of Birth:	00/00/0000
ILL Library:	ILL_LAW	Title Request Limit:	0010
ILL Total Limit:	9999	Language:	ENG
ILL Active Limit:	9999	Budget:	
Sponsor's ID:		Profile:	
Primary ID:		Home Library:	LAW
Proxy Type:	00	Dispatch Library:	
Mail Attachment:	H	<input checked="" type="checkbox"/> Data Export Consent	
		<input checked="" type="checkbox"/> Send All Letters to Patron	

Additional checks and blocks, active for limiting ILL privileges (for example, patron owes fines, patron has overdue loans), can be set within the configuration of patron circulation checks.

3 Borrowing requests

A borrowing (outgoing) request is made up of three parts:

- Bibliographic and item information
- Patron identifier and request parameters such as Need By Date, Pickup Location, Willing to Pay Fee, and so on
- Potential suppliers; only a single supplier is active at any one time

ILL borrowing requests are placed by, or on behalf of, patrons who have ILL privileges. Patrons can create requests in the Web OPAC – either from a displayed record (in which case bibliographic information is automatically taken from the record), or by filling in a blank form. Staff can create requests on behalf of a patron in the Integrated ILL GUI from a displayed record, or by filling in a blank form. Staff is limited to creating requests for patrons whose ILL Library (Unit) is the same as the staff user's ILL Unit authorization.

Processing of borrowing requests

As a request moves through processing, the request undergoes status changes. A status is changed by operator intervention (by a **Change Status** action), by system processing (for example, the result of a 'Locally owned' check), or by ISO ILL messages that are automatically registered by the system.

Each potential supplier listed for a particular request is also assigned a status, which changes through actions and processes. Sometimes the supplier status impinges on the request status (for example, when a check on the last potential supplier results in 'Locate Failed', the request status also becomes 'Locate Failed').

The ISO ILL Protocol and Implementation assigns statuses that will likely not be used in non-ISO communication, such as notification that the item has been shipped, notification that a requested item has been lent to the patron, and so on

These statuses are detailed in [Appendix A](#).

Some of the steps in the process are optional, and some of the steps in the process can be performed by the system in an unmediated manner. Therefore, the exact workflow of your library might match only some of the workflow steps described following.

For example, your ILL Unit might be set up to automatically process all NEW requests, assigning potential suppliers by performing 'Locate' on relevant suppliers (set up in the Supplier Roster), sending the request to the first supplier in the list, and automatically sending to the next supplier if the first supplier reports that he is unable to fulfill the request.

Each step in the workflow is dealt with in the following section as a manual (mediated) process.

All manual tasks related to borrowing workflow are performed in the Borrowing tab of the Integrated ILL GUI. Borrowing requests are grouped for view by status in the Summary view of the Borrowing tab. You will want to start in the Summary mode of the tab, in order to get an overview of, and to navigate to, the requests. This view acts as an index of the active ILL requests. Statuses that require action are listed in bold.

Actions are performed in the Functional mode of the Borrowing tab. The workflow is described in the following sections of this chapter. You will notice that after you

create a borrowing request (from the Borrowing menu, or from Search – Full Display – ILL Request), the interface immediately switches to the Borrowing tab in Functional mode, with the newly created request displayed, ready for action.

3.1 Creating ILL borrowing requests

As explained in the Staff User's Guide to the Web OPAC, a patron can create an ILL Borrowing request in the OPAC. The following section deals with creating a request in the Integrated ILL GUI module.

There are two options for creating an ILL request on behalf of a patron:

- From the Borrowing menu
- From full record display in the Search tab

To create an ILL request from the Borrowing menu

1. Click the Borrowing menu, or press ALT + B. Then click the relevant button for you chosen format (serial or non-serial), for example, **Create New Serial Borrowing Request**:

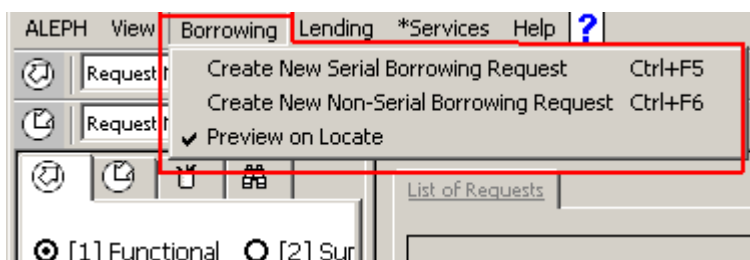

Or, click the buttons at the far right of the Borrowing bar (for Create New Serial Borrowing Request or Create New Non-Serial Borrowing Request):

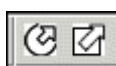

A form displays:

Note that slightly different forms display, depending on where you initiate the request (from the Borrowing Menu or from Full Record), and depending on the material type (Serial or Non-serial). The above is an example of a Serial form.

When a request has the Patron Note field filled in, it is automatically assigned a 'mediated' status.

2. Complete the form, and click Send.

If your ILL Unit is set to check for local ownership, the request is checked against the catalog (the logical base of the ILL Unit) when placed by patron in Web OPAC, or by ILL staff in the Integrated ILL GUI.

If it is found to be locally owned, a message pops up informing you of the situation. You can cancel the request, or continue, in which case the request status will be set to "Locally Owned". In any case, whether the status is New, New Mediated or Locally Owned, you are transferred to the Borrowing tab, in Functional mode, to continue processing the request.

To create an ILL request from the full record display in Search mode

1. After finding a relevant record, from the full bibliographic record display in the lower pane, click ILL Request:

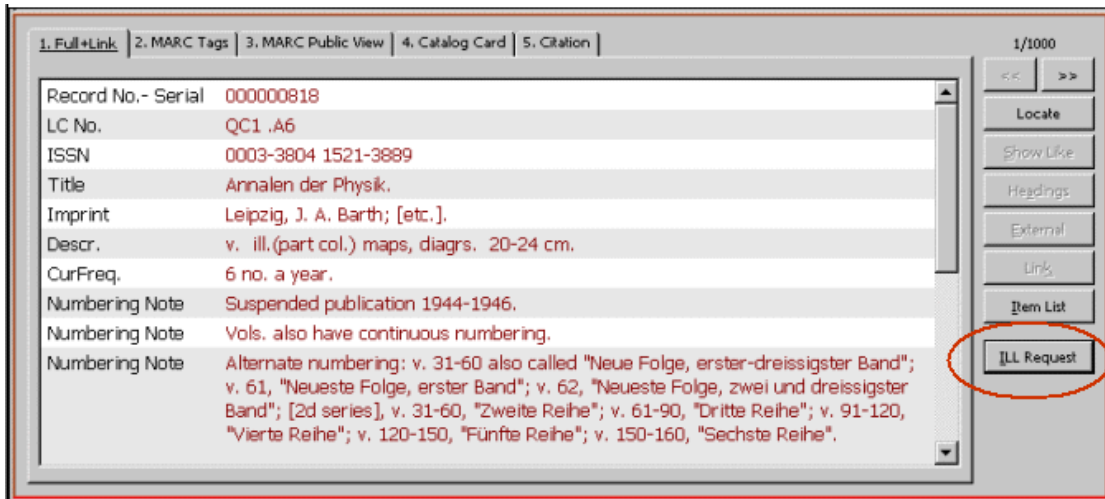

2. A pop-up window appears; choose **Borrowing Request**.

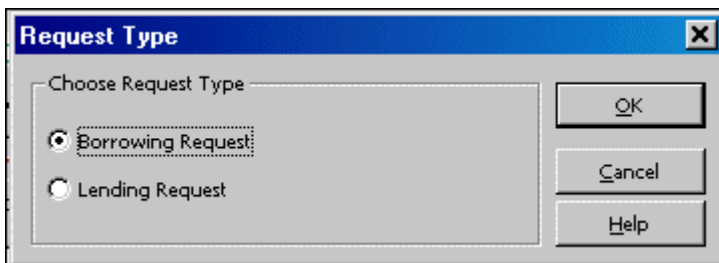

A Serial or Non-serial form pops up, with the bibliographic information displayed in the form. Here is an example of a non-serial form:

New Borrow Non-Serial Request

Patron ID: [Field]

Patron Name: [Field]

Level of Service: [When convenient]

Volume: [Field]

Title of Part: [Field]

Author of Part: [Field]

Source: [Field]

Requested Pages: [Field]

Patron Note (Free Text): [Field]

Note (Free Text): [Field]

Delivery Information

Pickup Location: [Law Library]

Need by Date: [00/00/0000]

Language: [ENG]

Requested Media: [Field] Allow Other Media

Media Send Method: [Email]

Send Directly to Patron Willing to Pay Fee Copyright Signed

Bib Information

Oeglin, Erhard, d. ca. 1520. [Aus sonderer künstler Art und mit höchstem Fleiss seind diss Gesangbücher mit Tenor Discant Bass und Alt corgiert worden in der kayserlichen unnd dess hailigen Reichs Stat Augspurg...]

Buttons: Send, Cancel, Help

Note that slightly different forms display, depending on where you initiate the request (from Main Menu or from Full Record), and depending on the material type (Serial or Non-serial). When the request operation is initiated on the Full Record in Search, the bibliographic information displays, but cannot be updated; the Serial request includes fields for specifying volume and issue information.

3. Complete the form, and click **Send**.

If your ILL Unit is set to check for local ownership, the request is checked against the catalog (the logical base of the ILL Unit) when placed by patron in Web OPAC, or by ILL staff in the Integrated ILL GUI.

If it is found to be locally owned, a message pops up informing you of the situation. You can cancel the request, or continue, in which case the request status will be set to “Locally Owned”. In any case, whether the status is New, New Mediated or Locally Owned, you are transferred to the Borrowing tab, in Functional mode, to continue processing the request.

3.2 Handling New Borrowing Requests

The Borrowing workflow begins with the existence of a new borrowing request, created by a library patron in the Web OPAC, or by an ILL staff member in the Integrated ILL GUI, as described in the previous section, [3.1 Creating ILL borrowing requests](#). These requests are initially assigned the status NEW, NEM (New-Staff Review) or LOW (locally owned). The request status is NEM if a patron note has been registered in the request; the request status is LOW if a “locally owned” check was performed and the result was positive; otherwise the status is NEW.

In case of SLNP, new requests are initially assigned the status SV because the central ILL server has already notified the potential supplier. If the request contains a note, the status is NEM. The requests do not need any further handling until the material arrives [3.1](#).

You work with new requests in the Integrated ILL GUI’s Borrowing tab, in Functional mode, where requests can be processed and where actions can be taken.

Title	Request No.	Status	Last Activity	Msg	Rush
Narrative of a voyage, in His Majesty's late ship Alceste, to the Yellow Sea : along the coast of Co	118	Loaned to Library	2005/12/04		When convenient
Narrative of a voyage, in His Majesty's late ship Alceste, to the Yellow Sea : along the coast of Co	121	Sent to supplier	2005/12/05		When convenient
Nonmunjip - Kyŏngsang Taehak.	58	Locate failed	2006/10/04		When convenient
Selected works / Sigismond Thalberg ; edited by Jeffrey Kalberg.	128	Closed	2005/12/22		When convenient
Selected works / Sigismond Thalberg ; edited by Jeffrey Kalberg.	171	Will be Supplied	2005/12/12		When convenient
Selected works / Sigismond Thalberg ; edited by Jeffrey Kalberg.	172	Renewal - Accepted	2005/12/18		When convenient
Selected works / Sigismond Thalberg ; edited by Jeffrey Kalberg.	173	Returned by Library	2005/12/22		When convenient
A short outline of the history of the Far Eastern Republic.	346	Closed	2007/05/16		When convenient
Strong words from Mr. Redmond. : Treason to the home rule cause.	273	Sent to supplier	2005/12/19		When convenient
Strong words from Mr. Redmond. : Treason to the home rule cause.	274	Waiting for Renewal Reply	2005/12/18		When convenient
Strong words from Mr. Redmond. : Treason to the home rule cause.	276	Sent to supplier	2005/12/19		When convenient

The nodes in the Functional mode of the Borrowing tab are “Borrowing Request List” (with display of the count of the number of requests in the list), “Borrowing Request” (with display of the request number and status of the request currently highlighted in the list), and sub-node “Request Log” (for displaying the log of the request). The Bulk Operation nodes do not concern us here.

In order to work with a request, select it in the upper pane. The request information displays in the lower pane, for view only; the action buttons that are relevant for a new request are located to the right of the list in the upper pane.

To view new requests

1. Open the Borrowing tab (click the tab or press F5) and click Summary mode. This is the starting place for handling requests.

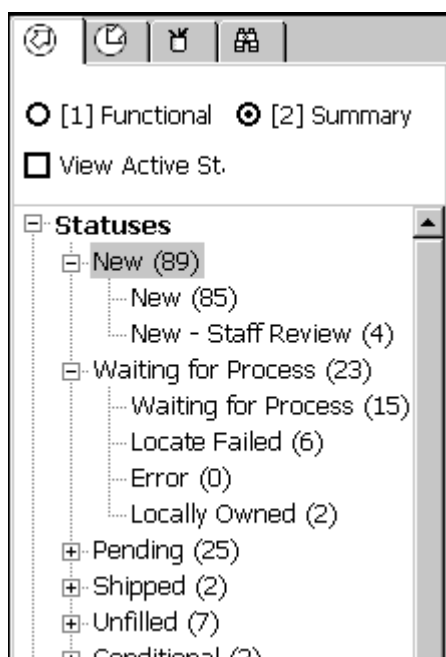

From here, you can choose a status category, select the requests, and move them into the Functional mode for further action.

Refer to [1.2.1 Screen elements](#) on page [10](#) above for an explanation of the Summary mode and how to work with it.

If your NEW requests are processed automatically, you should ignore the “New” sub-node in the Summary. If requests in this status pile up, this can be an indication that the automatic processing has stopped, and you should inform system personnel of the situation.

You should, however, deal with “New – Staff Review” and “Locally Owned” requests.

2. Select the New, New – Staff Review or Locally Owned folder, to display summary information, and to select requests for processing:

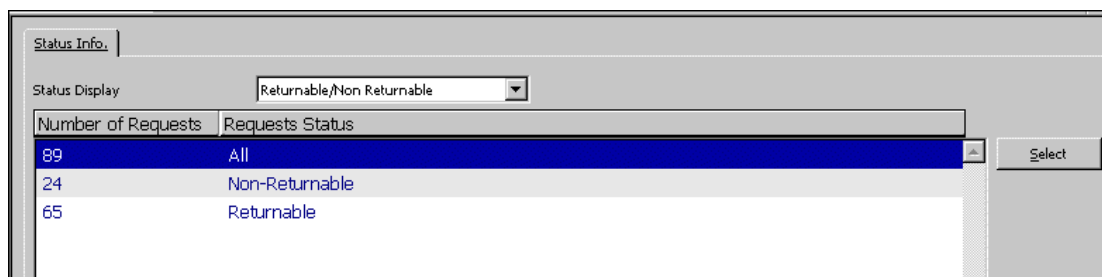

You can choose a Status Display group from the drop-down list. Although the list offers grouping by:

- Type of request (Returnable/Non-returnable)
- Active Supplier

- Open Date
- Last Activity Date
- Shipment Method

only Type of request and Open Date are relevant for NEW requests.

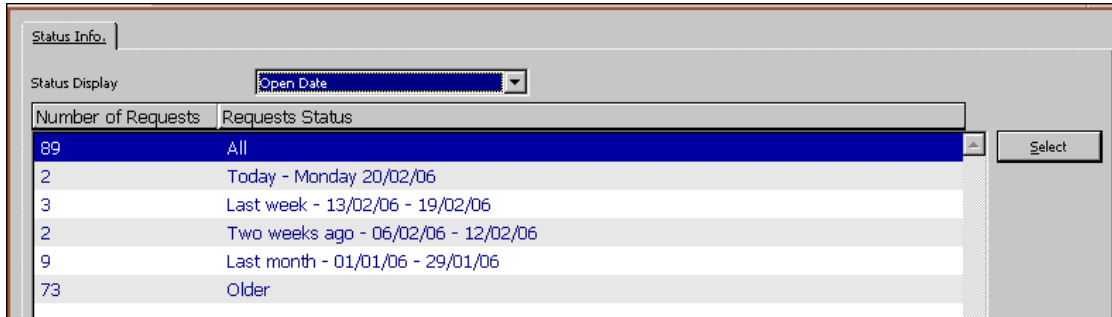

- To work on a group of requests, highlight a line to select it, and click **Select**, or double-click the line. The Borrowing tab changes to Functional mode, where requests can be processed and where actions can be taken.

3.2.1 Locating possible suppliers

Note

“New Requests” refers to all requests that are New, New – Staff Review or Locally Owned.

The first task when dealing with new requests is to identify possible suppliers. Clicking the **Locate** button from the List of Requests initiates searching for the requested title on the catalogs of the possible suppliers, and thereby builds the list of potential suppliers for the request. The list of suppliers that are checked has been pre-configured for your ILL Unit, sensitive to the request type and the requested media.

You can display a “Locate Preview” window to review the “locate” process, to see which suppliers were checked, and the outcome of each check.

To preview the Locate process:

From the Borrowing menu, select “Preview on Locate”:

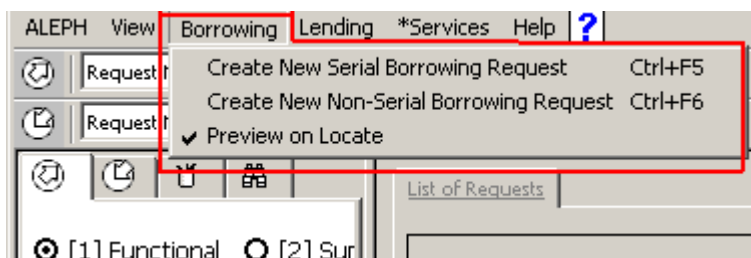

When you click **Locate** from the List of requests, the Locate Preview window displays:

Supplier	Level	Pos.	Note	Base	Type	Request	#Bib. Hits	#Items
HYL ILL Unit-East Asian	1	1	Supplier is valid	HYL	UNIT	wti= (barbarians and 1603-1868)	0	0(0)
Law ILL Unit	1	4	Supplier is valid	LAW	UNIT	wti= (western barbarians in japan and formosa in tokugawa days 1603-1868)	0	0(0)
MED No-ISO Unit	1	6	Supplier is valid	MED-1	UNIT	wti= (western barbarians in japan and formosa in tokugawa days 1603-1868) and wau= (paske-smith m) and wpl= (kobe japan)	0	0(0)
				MED	UNIT	wti= (barbarians and 1603-1868) and wau= (paske-smith m)	0	0(0)
MED ILL Unit-Medicine	1	2	Supplier is valid	MED-1	UNIT	wti= (western barbarians in japan and formosa in tokugawa days 1603-1868) and wau= (paske-smith m) and wpl= (kobe japan)	0	0(0)
				MED	UNIT	wti= (barbarians and 1603-1868) and wau= (paske-smith m)	0	0(0)
HYL ILL Unit-East Asian	2	1	Supplier is valid	USM40	UNIT	wau= (paske-smith m) and wti= (barbarians and 1603-1868) and wpr= (1930)	0	0(0)
HYL ILL Unit-East Asian	99	1	Supplier is valid					

The Locate Preview window shows you successes and failures. The list shows each supplier listed in the roster, the level and position within the roster level, a message on supplier status, the code of the base on which the search query is performed, the supplier type (internal, external, and so on), the search query, and, for each, the number of matching bibliographic records found, and the number of relevant item records found.

To complete the process, click **Locate** in the Locate Preview window. If the locate is successful, suppliers are assigned to the request, and the request status changes to “Waiting for Process”:

Title	Request N	Status	Last Act	Msg	Rush
Java for COBOL programmers, third edition [electronic resource] / John C. Byrne.	661	Waiting for Process	23/08/12		When convenient

If the locate does not succeed in finding a possible supplier, the request status changes to “Locate Failed”.

If you do not want to perform the Locate action at this time, click **Cancel**.

When there is a technical problem (in the locate process) such as a wrong IP address or a communication problem, the potential partner is displayed on the list and the "Note" column contains an error message, indicating that the process has failed for this partner.

3.2.2 Assigning potential suppliers

The **Locate** process assigned potential suppliers, and now the Suppliers tab displays in the lower pane:

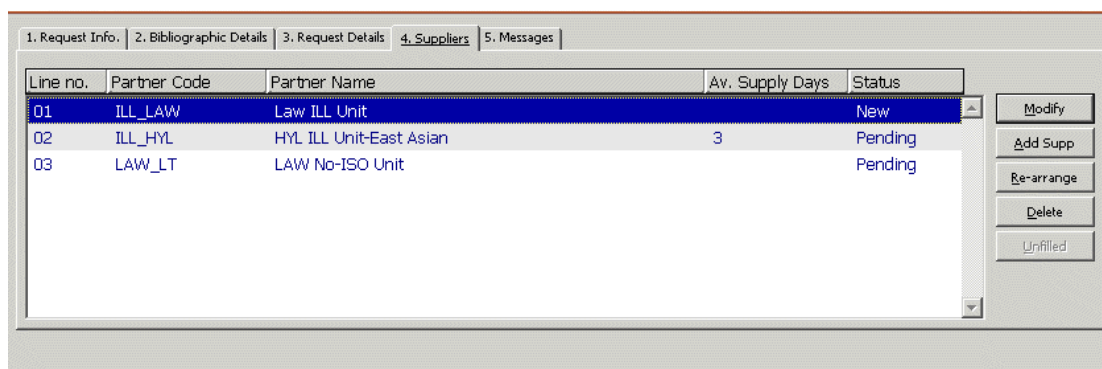

The request is sent to the suppliers in the order in which they are listed. There is no need for action when this tab displays, but you can add or delete a supplier, modify a supplier's parameters, or re-arrange the order of the list.

To	Do this
Add a supplier, without performing a "Locate" check	Click Add . The Add Supplier window displays.

Note
For detailed information about the various fields, refer to Integrated ILL online Help.

Modify a supplier	Click Modify .
Change the order of the list in the Suppliers tab	Click Re-arrange . A window pops up, enabling you to manually change the order of the list, and thereby change the order in which the suppliers are chosen.

To change the order of a supplier in the list, in the pop-up window, type a line number identifying where you want to place the Supplier in the list. The Supplier list will be re-sequenced and re-numbered.

Remove a supplier from the list	In the Supplier tab, select the relevant supplier, and click Delete .
---------------------------------	------------------------------------------------------------------------------

To	Do this
Dispatch the request to the first supplier in the list	In the List of Requests, click Send . The request will be sent electronically, by e-mail, or a form will print, depending on supplier configuration.
Prepare print/output for different purposes	<p>In the List of Requests, click Print. The options available include:</p> <ul style="list-style-type: none"> • The request details, for internal use • Letter to patron requesting additional information • Letter to patron requesting copyright affirmation <p>The Print Form lets you change the request status of not-yet processed requests to New-Staff Review. A request which has already been sent out to a supplier can be changed to: Waiting-Patron Reply.</p>
Change a highlighted request's status to Deleted	In the List of Requests, click Delete . This removes the request from any further processing.
Change a highlighted request's status to Deleted or Canceled or any other status that your system setup configuration supports.	<p>Click Change Status. A window pops up allowing you to choose the status, and, optionally, to enter a note. The note is entered in the Request Log.</p> <p>Both Deleted and Canceled remove the request from further processing. Functionally, there is no difference between changing the status to Delete, and using the Delete button.</p>
View, check and change copyright status, and enter copyright payment information	Click Copyright . This button is active only for non-returnable requests' material and only if your library has implemented the USA copyright standard.

3.3 Following up borrowing requests

There are three tools at your disposal for follow-up:

- Request status node – monitor the follow-up request statuses; some ISO ILL messages trigger automatic change of the request status; in other cases, you might want to change the status manually.
- Messages node – monitor the messages sent by the potential supplier

- Batch services/reports – Identify requests that were expected to have been supplied or acknowledged within a reasonable period of time (within the average supply days that has been set for the request at the supplier).

3.3.1 Viewing borrowing requests' statuses

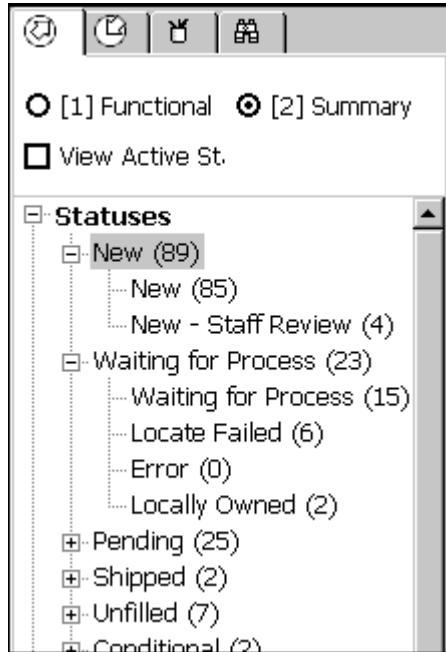

Some of the Status nodes that display in the left Navigation pane of the Borrowing tab's Summary mode (illustrated above) must be monitored in order to advance a request from one status to another. Other nodes can be used to verify that processes are working smoothly. Following is a list of the statuses for as they display. The statuses that are emphasized in bold are the statuses that you will want to examine for follow-up. Statuses marked with an asterisk are related to ISO ILL messages or automatic processing, and **must** be monitored in order to move a request along.

Status	Explanation
Canceled	
Closed	
Conditional Reply *	The Supplier has sent a message indicating the conditions under which an item may be borrowed.
Damaged	
Estimate Reply *	The Supplier has sent an ESTIMATE message, giving you an estimate of the cost to provide the service requested.
Expired	
Hold Placed	
Loaned to Library	ILL Material received from supplier but not yet loaned to patron
Loaned to Patron	ILL Material is currently loaned to patron

Status	Explanation
Locally Owned	
Locate Failed *	The LOCATE action did not succeed, and Potential Suppliers have not been assigned for the request.
Location Reply *	The Supplier has sent a LOCATIONS message, giving location information, in response to the request query.
Lost	
New	
New – Staff Review	
Overdue *	The supplier has notified you that the item is now overdue; you will now have to inform your patron.
Pending	
Recall	
Recalled *	The Supplier has recalled the item; you will now have to inform your patron.
Received	
Renew Accepted *	Your request for renewal has been accepted; you will now have to change the local due date of the item, and (optionally) inform your patron.
Renew Rejected *	Your request for renewal has been rejected; you will now have to inform your patron.
Renewed	
Replies – Staff Review	
Retry *	The Supplier has sent a RETRY message, informing you that the material is not currently available, and you should retry at a later time. You might decide to move the request on to another supplier.
Returned	
Returned by Library	For ISO partners: ILL material returned to supplier and request 'waits' to supplier's check-in message.
Returned by Patron	ILL material returned by the patron to the library. Not yet returned to supplier
Sent to Supplier	
Shipped	
Unfilled *	The last assigned Potential Supplier has reported that he is unable to supply the request.
Waiting Cancel Reply	
Waiting for Process	The request has an active Potential Supplier, but the request has not yet been sent. If your library uses

Status	Explanation
	automatic processing, this status group should not have requests piled up.
Waiting Patron Response	Pending status- The request has already been sent to the supplier but additional information has been requested by the supplier. Letter sent to patron to clarify the issue.
Waiting Renew Reply	
Will be supplied	

3.3.2 Handling messages in the Messages node

The Messages node includes messages received via the ISO ILL Protocol. Not all messages display here; a message that triggers a change in the request status is not displayed here, since it will be handled through the Status nodes.

Messages that are received in a manual manner can be registered in the request log; they are not reflected in the Messages node.

ISO ILL Electronic Messages

Messages that are received from ILL partners through the ISO ILL Protocol are automatically registered in the system. In some cases these messages change the status of the supplier, and/or the status of the request. The new status can trigger further processing. For example, if the supplier sends an “Unfilled” message (that is, the supplier cannot fulfill the request), the supplier status automatically changes to Unfilled, and the status of the next potential supplier automatically changes to Waiting for Process (that is, ready to send). When an unfilled message is received from the last supplier in the list, the request status changes to Unfilled.

The message nodes display the following ISO ILL message types:

- **Cancel reply** - These are the replies that suppliers have sent in response to your messages requesting that a request be canceled. A (False) reply does not influence your request’s status; a (True) reply changes the supplier status to Canceled, and manual follow up is now required for the request.
- **General Message** - These are messages of a general nature
- **Status Query** - This is a message for consistency checking; it is automatically replied to by the system.
- **Status or Error Report** - This is a system message for cases where a message does not conform to the ISO standard.

The number in parentheses on the message nodes is a count of the number of messages of this type.

Choose a Message node in order to display and work with the requests and the messages.

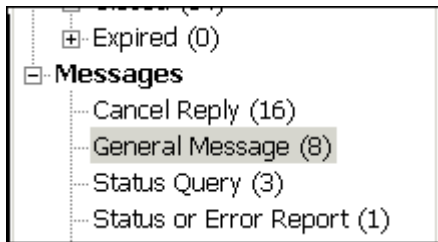

The upper section of the Messages pane displays active messages:

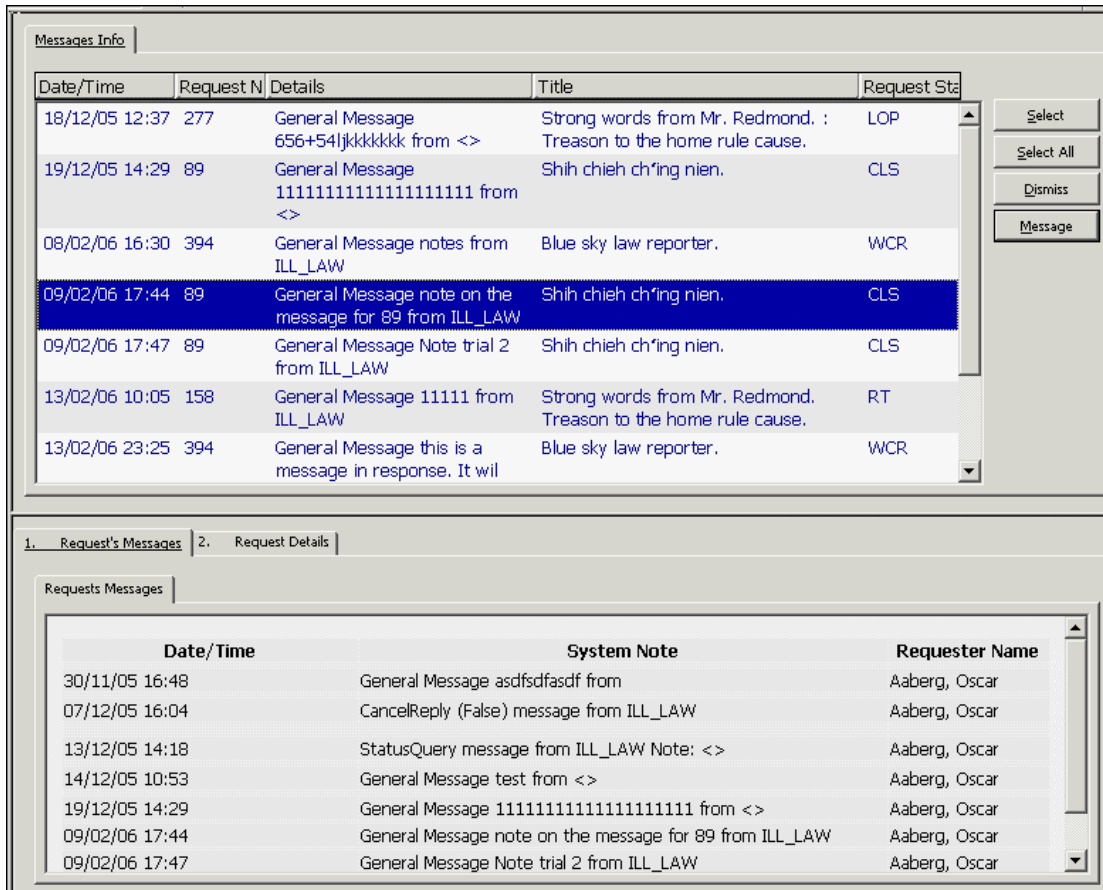

A message is active until it is “dismissed” by a staff user; it can be dismissed in either the Summary mode or the Functional mode. A dismissed message can be reactivated in the Functional mode.

When you choose a line in the list, request information and significant messages that have been received for the request (both active and dismissed), display in the tabs of the lower pane.

To	Do this
Remove a request from the messages view	Click Dismiss . It remains registered and viewable when a single request displays in the Functional mode.
Send a response to the supplier	Click Message . The Message button is active only for General messages.

In addition to providing message information, the Messages Pane is your “gateway” to functional handling of requests for which messages have been received. To handle

the requests, click the **Select** or **Select All** button. This moves the requests and the interface to the Functional mode.

Manual messages

Your ILL Partner might send you a message concerning your request. You can update the request, register the message in the log, and/or change the supplier status. There are different ways of handling each situation; there is no one hard and fast rule and guidelines should be set up by your library.

For example, if the supplier informs you that he cannot fulfill the request, you will update the supplier status to Unfilled, this triggers an automatic update of the next potential supplier to New, and the request status automatically changes to Waiting for Process (that is, ready to send). You can then either click **Send**, or let automatic processing dispatch the request.

When you report Unfilled for the last supplier in the list, the request status changes to Unfilled. You might immediately inform your patron, or you might deal with all Unfilled requests as a group. Rather than reporting Unfilled, you might prefer to change the status request to Canceled. These are only examples of how these situations might be handled.

3.3.3 Available borrowing-related batch services / reports

You can access batch services from the Services menu. The following services relate to borrowing requests.

Claim Report and Letters (ill-73)

This batch service creates a report of all non-ISO “Sent to Supplier” requests that have not been received up to the date expected. The service can be set to prepare a report and/or a “claim” notice that is sent to the supplier.

Static Status Requests Report (ill-66)

This batch service (ill-66) creates a report of all open requests that have remained in the same status for an excessive length of time.

3.4 Receiving material from suppliers

Material receipt and the resulting processes are different for Returnables, Non-Returnables, and for material supplied directly to the patron.

- **Returnables** – Receipt of returnable material triggers the creation of temporary item records that are deleted when the items are returned to the supplier. The item status of the checked in material determines (in accordance with your library’s setup) whether the loan to patron is performed immediately, or whether it is performed later, when the patron picks up the material. The request is CLOSED when the material is returned to the supplier.
- **Non-Returnables** – Non-returnable material is material that is handed over to the patron, with no need for follow-up or return to the supplying library.

Receipt of non-returnable material does not create item records, and immediately changes the request status to CLOSED.

Receipt of material from the supplier can be registered in one of two ways:

- By accessing the particular request, and clicking the **Receive** button on the selected request from the List of Requests
- By entering the request number in the Bulk Operation window

Bulk receipt is a more efficient way to check in material, but it requires that you have the request number in hand. It differs from receiving a single request in that costs and notes cannot be entered.

To receive a single request (returnable or non-returnable)

1. In the List of Requests, select a request and click **Receive**.

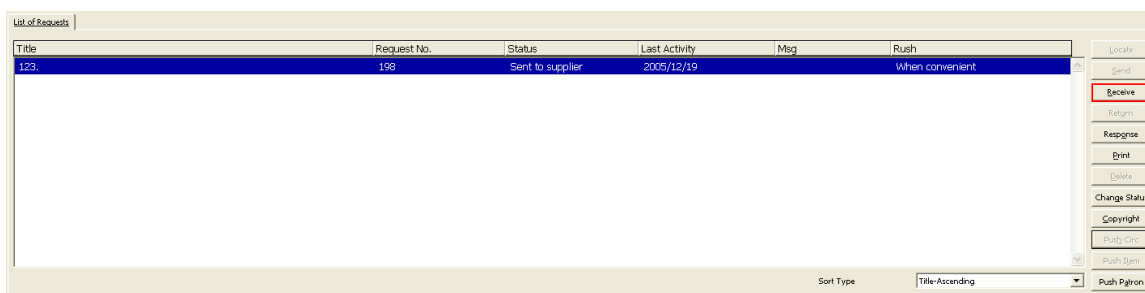

This initiates registering receipt of the material. A window pops up so that you can choose whether the material is returnable or non-returnable.

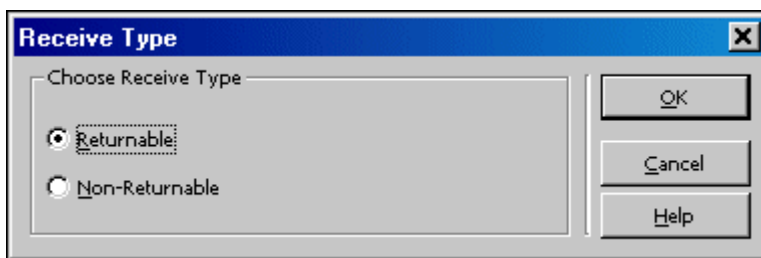

2. Choose a Receive type, for example, “Returnable”, and click OK, after which a form displays for you to complete:

Receive Returnable Material

1. Request 2. Items

Date Received: 30/10/2011

Media Arrived: Printed (Loan)

Expected Return Date: 27/11/2011

Item Status: 72 Home Loan (02)

Supplier Currency:

Supplier Cost: 0,00

Supplier Local Cost: 0,00

Patron Local Cost: 0,00

Note:

Shelving:

Send Received Letter To Supplier

OK
Refresh
Cancel
Help

Note

For detailed information about the various fields, refer to Integrated ILL online Help.

To receive requests in bulk (returnable or non-returnable)

In the Navigation Tree, select one of the Bulk Operation nodes (either **Bulk Operation – Receive Returnable** or **Bulk Operation – Receive Non-Returnable**). The right pane displays a check-in form:

1. Bulk - Receive Returnable | 2. Items

Fill Data To Send

Item Status: 72 Home Loan (02)

Expected Return Date: 30/10/2011

Arrived Media: Printed (Loan)

Send Receive Letter to Supplier

Enter Request Number: 949

Patron ID	0000012
Patron Name	Aaberg, Oscar
Patron Status	Faculty
Patron Type	
Patron Expiry Date	18/09/2014
Patron Status (during loan)	
Patron's Due Date	
Home Library	
ILL Unit	ILL_HYL
Open Date	09/10/2011
Requested Media	Printed (Loan)
Level of service	When convenient
Pickup Location	Home address
Patron Note	
Staff Note	
Need by Date	09/10/2013
Copyright Compliance	
Copyright Declaration Signed	No
Willing to pay	No
Requested Send Method	Email
Send Material Directly to Patron	No
Active Supplier	ILL_LAW
Active Supplier Request No.	
Request to Supplier Status	Sent to supplier
Active Supplier Protocol Type	Letter
BL Keywords 1	
BL Keywords 2	
Required Return Date	
Supplier Cost	0.00
Supplier Currency	
Barcode	

This window is used for reporting receipt of returnable material, that is, the material that must be returned to the lending library. Temporary items are created in your library so that you can loan the material to your patron for follow-up.

After you click **Send**, the details of the request display in the lower portion of the window.

Note

For detailed information about the various fields, refer to Integrated ILL online Help.

3.5 Renewing Material on Loan

Renewing of ILL material is treated differently than regular renewals – some of the ILL protocols require requesting renew permission from the lending library. The actual renewal of the loan can occur only after a reply confirming that renewal is possible for the item is received from the lending library.

3.5.1 Sending a Renew Request

In the List of Requests, select a request and click Response → Renew. The following form is displayed:

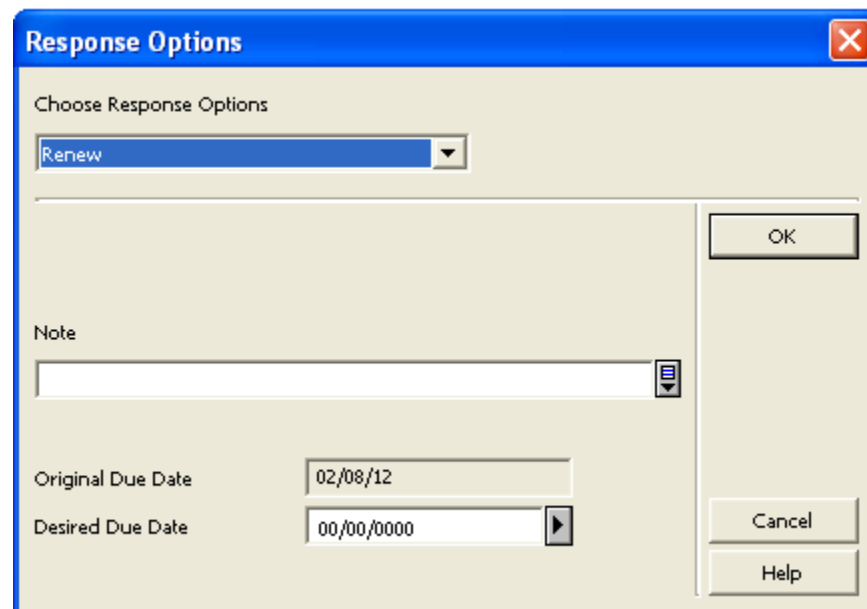

The Original Due Date is displayed. This is the date by which the item must be returned to the supplier.

After entering the desired due date and clicking **OK**, the status of the request changes to Waiting for Renewal. The renewal request is sent to the supplier.

3.5.2 Renew Accepted

After receiving a reply from the Lending Library, the loan can actually be renewed. The ILL staff performs the actual renewal manually by selecting **Renewal - Accepted** from the Choose Status drop-down list:

The request status is updated to Renew Accepted (RNA) if this relevant according to the protocol. (This is not relevant for BL protocol). A new due date is calculated for the loan according to the library's regular renew policy. This includes overdue fine creation.

Note that for the ISO protocol, this is done automatically when the Renew Answer message is received, stating that a request can be renewed.

Note:

In the case of multiple temporary items, all of the items' loans are extended.

3.6 Renewing and Recalling Material on Loan to Patrons via GUI-Circ

The ILL loan to patron can be renewed in the Circulation Module.

From the Patron's ILL Request list:

1. Highlight the ILL request in ILL Requests of the Patron Activity.
2. Click **Renew**.
3. Type the desired new due date.

The status of the request changes to Waiting for Renewal. The renewal request is sent to the supplier.

Bibliographic Info	Date	Status	Due Date	Req.Media	Pickup
test for barcode1.	07/01/2008	Loaned to Patron	01/02/2008	Printed (Loan)	Law Library
test for barcode2.	07/01/2008	Loaned to Patron	01/02/2008	Printed (Loan)	Law Library
Test for barcode3.	07/01/2008	Loaned to Patron	01/02/2008	Printed (Loan)	Law Library
TEST FOR BARCODE4.	07/01/2008	Loaned to Library	Loan request has arrived	Printed (Loan)	Law Library
TEST FOR BARCODE5.	07/01/2008	Loaned to Library	Loan request has arrived	Printed (Loan)	Law Library
Music and Art.	07/01/2008	Loaned to Library	Loan request has arrived	Printed (Loan)	Law Library
The whole contention between the two famous	01/04/2008	Shipped		Printed (Loan)	Medicine Library

In addition, it is possible to renew the ILL material like any other loan (from the Patron loan list, item loan, and in the Renew by Barcode option).

From the Patron Loan List:

1. Highlight the ILL loaned material in Loans list of the Patron Activity.
2. Click **Renew Marked**.
3. Type the desired new due date.

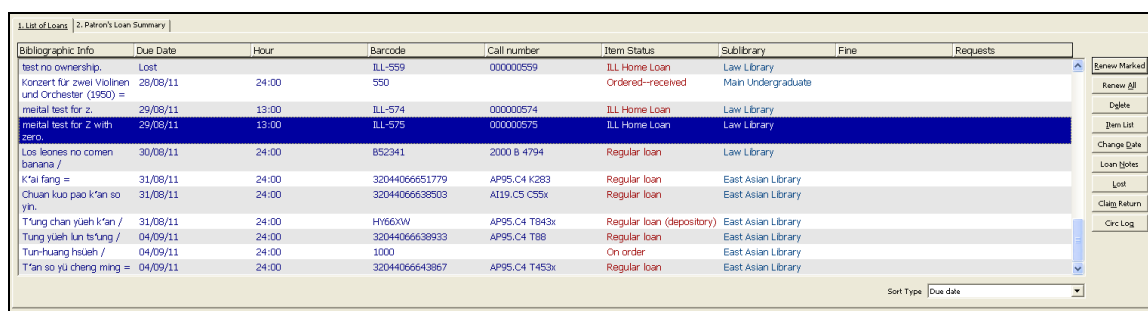

The status of the request changes to Waiting for Renewal (when relevant according to the protocol type). The renewal request is sent to the supplier.

Note: The SLNP protocol does not require asking the lending library for renewal permission. Therefore, for this protocol, the loan period is extended without sending a renewal request to the supplier.

Note: Depending on the system setup, patrons may renew loaned ILL items via the Web OPAC.

Recalling an ILL loan can be performed by the system or done manually. Click **Change Date** in the Circulation loans list and enter the recall date manually (minus the return delay). In addition to this, the recall letter to patron should be issued from the ILL module. See [Corresponding with the Supplier](#) on page 51.



The automated workflow for recalling, involves setting up the recall policy for ILL material, placing a hold request on the recalled item, and generating the recall letter using p_cir_13 service. The recall date for the ILL material will be generated by the system.

3.7 Returning material to suppliers

The return of material to a supplier can be registered in one of two ways.

- By accessing the particular request, and clicking the **Return** button on a selected request from the List of Requests
- By entering the request number in the Bulk Operation window.

It is more efficient to check in material in bulk, but it requires that you have the temporary item barcode or the Request Number in hand. It differs from returning a single request in that a note cannot be entered.

Note:

When material is received from a supplier, temporary items/barcodes are created. The material is loaned to the requesting patron for follow up.

If the patron checks in these temporary items in Circulation, depending on your library's setup, one of the following happens:

- A warning pops up informing Circulation staff that this is an ILL item, which should be transferred to the ILL staff for further processing; the patron's loan is checked in, and the ILL request status changes to "returned by patron"
- The patron's loan is checked in, and the ILL process is completed as well.

If the patron returns the item directly to the ILL staff, when the item is processed for return to supplier, check-in of the patron's loan is automatically triggered.

Note:

If the borrowing request has multiple items, the following message is displayed:

This request has x related items. Continue?

Verify that all related items are returned. If they are not, click **Cancel**.

To return from a single request

In the List of Requests, select a request and click **Return**:

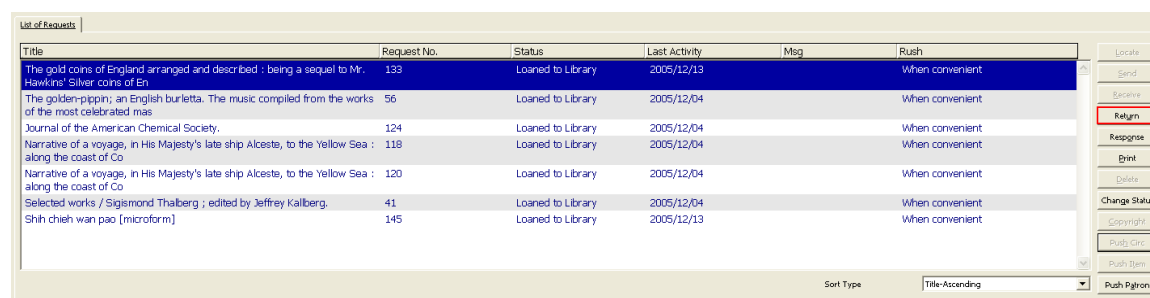

Title	Request No.	Status	Last Activity	Msg	Push
The gold coins of England arranged and described - being a sequel to Mr. Hawkins' Silver coins of En	133	Loaned to Library	2005/12/13		When convenient
The golden-pippin; an English burletta. The music compiled from the works of the most celebrated mas	56	Loaned to Library	2005/12/04		When convenient
Journal of the American Chemical Society.	124	Loaned to Library	2005/12/04		When convenient
Narrative of a voyage, in His Majesty's late ship Alceste, to the Yellow Sea : along the coast of Co	118	Loaned to Library	2005/12/04		When convenient
Narrative of a voyage, in His Majesty's late ship Alceste, to the Yellow Sea : along the coast of Co	120	Loaned to Library	2005/12/04		When convenient
Selected works / Sigismond Thalberg ; edited by Jeffrey Kalberg.	41	Loaned to Library	2005/12/04		When convenient
Shih chieh wan pao [microform]	145	Loaned to Library	2005/12/13		When convenient

Sort Type: Title-Ascending

Buttons: Localize, Send, Reserve, **Return**, Resgnose, Print, Delete, Change Status, Copy/Print, Push Circ, Push Item, Push Patron

This initiates registering of the return of the material. The following form displays:

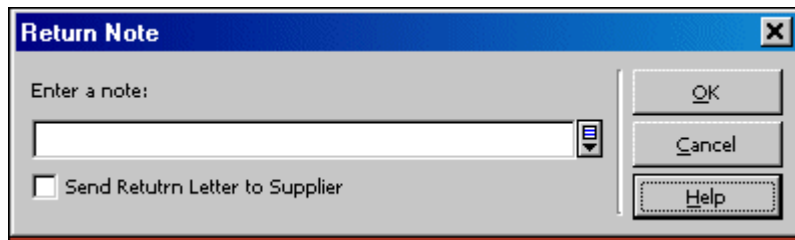

If the communication with the requester is through the ISO ILL protocol, the text entered in the field will be attached to the Checked In message.

If the "Send Checked-In Letter" check box is selected, and the requester does not communicate through the ISO ILL protocol, the text entered in this field will be included in the letter that is sent.

To return in bulk

1. In the Navigation Tree, select the **Bulk Operation – Return** node. The right pane displays a check-in form:

Patron ID	00000036	
Patron Name	Aadband, Dustin	Morand, Paul, 1888-1976..
Patron Status	Faculty	Green shoots, / by Paul Morand; introduction by A. G. Walkley,
Patron Type	Arts and Sciences	New York, :: T. Seltzer, 1924..
Patron Expiry Date	18/09/2012	152 p. ; 20 cm.
Patron Status (during loan)		Woolf, H. I.
Patron's Due Date		
Home Library	Law Library	
ILL Unit	ILL_HYL	
Open Date	20/09/2011	
Requested Media	Printed (Loan)	
Level of service	When convenient	
Pickup Location	Home address	
Patron Note		
Staff Note		
Need by Date	13/12/2011	
Copyright Compliance		
Copyright Declaration Signed	No	
Willing to pay	No	
Requested Send Method	Email	
Send Material Directly to Patron	No	
Active Supplier	ILL_HYL	
Active Supplier Request No.		
Request to Supplier Status	Closed	
Active Supplier Protocol Type	Letter	
BL Keywords 1		
BL Keywords 2		
Required Return Date	18/10/2011	
Supplier Cost	0.00	
Supplier Currency		
Barcode	ILL-774	

This window is used for reporting the return of the supplied loaned material to the lending library.

To send the lender a "Returned" notification, select the Send Return Letter to Supplier check box. If you use the ISO ILL Protocol to communicate with the requester, the notification will automatically be sent, and the check box is not taken into account.

2. Type the barcode of the item being returned (this is the temporary barcode assigned when the material was received), or the Request Number, and click Send. The updated details of the request display in the lower pane.

Note that if the request has multiple items, the barcode of any of the items can be entered to return all of the items.

3.8 Other Borrowing Request Activities

3.8.1 Corresponding with the Supplier

You can correspond with the supplier at various stages of the borrowing ILL workflow from the Borrowing Request List by clicking Response. This opens the Response Option Form which contains various communication types that you can send to the supplier:

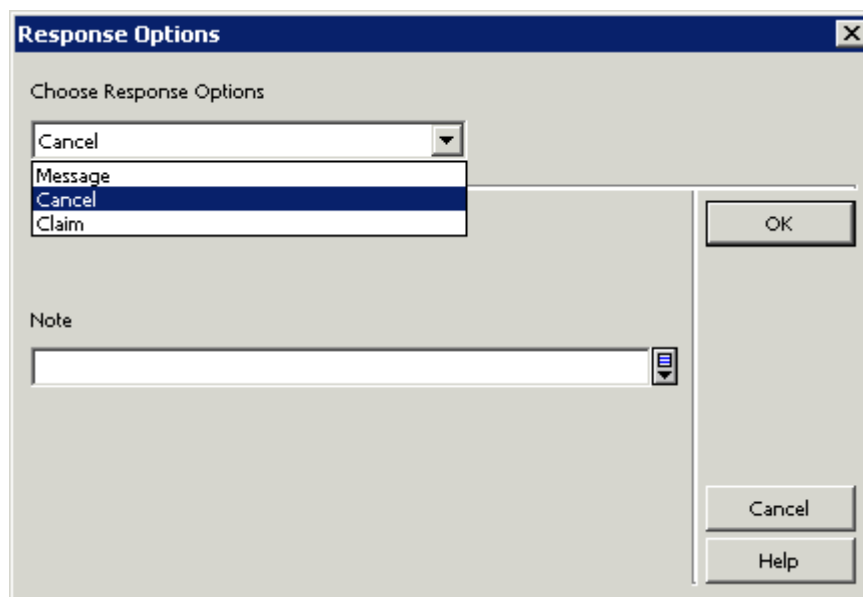

The response options that are listed are sensitive to the request status.

For example:

A borrowing request that has just been sent to a supplier but not yet received, will have the following options:

- General Message
- Cancel
- Claim

A borrowing request that has been registered as 'Received' but not yet returned to the supplier, will have the following options:

- General message
- Renew
- Lost
- Damaged

3.8.2 Copyright

The Copyright button of the Borrowing Request is active only if your library has implemented the USA copyright standard.

Copyright Management is enabled for non-returnable requests (copy or electronic media).

The GUI-ILL Borrowing interface enables you to view the copyright status and the overall copyright summary of the title within the pre-defined number of years. In addition, you can update/recalculate the copyright status.

To access the Copyright Management window, from the Borrowing Request Lists, click **Copyright**. The **Copyright** button is enabled for each non-returnable request (copy or electronic).

Copyright Management

Copyright Information

Title L The Quarterly journal of economics.
ISSN/ISBN L 0033-5533
Year 2003
Copyright Status 11-Might be under max of free copies

Current Copyright Summary

Filled Requests 0
Outstanding Requests 1 - Req. No:65

Update Copyright Status

Change Copyright Status to 11-Might be under max of free copies Recalculate

Note

Copyright Payment

Approval Number
Payment Status

OK
Cancel
Help

The Copyright Management window displays the following information:

- **Request information:** title, ISSN/ISBN and year
- **Request latest copyright status.**
- **Copyright Summary** of the title within the pre-defined range of years. The summary shows the current number of outstanding and filled requests for the title within the pre-defined range of years. The counters include the current request. All related request numbers are listed. Note that this summary is updated each time the Copyright Management window is opened so it might happen for example that the copyright status shows "11-Might be under the max of free copies" but the counter of 'Outstanding Request' is already above the max of free copies.

The Copyright Management window allows a staff user to update the copyright status in one of the following ways:

- Change copyright status – the staff user may update the copyright status to one of the following final statuses:
 - 00 - Free of copyright fee
 - 10 – Under maximum number of free copies
 - 20 - Above maximum number of free copies

A request with a 'final' copyright status is not checked again by the system upon request fulfillment therefore, the manual changed will not be overridden by the automatically system calculation.

To change the copyright status, select the required status from the list, you may add a free-text note. To perform the action, click the OK button. The manual update and the note (if exist) are written to the Request Log transaction.

- **Recalculate** – The 'recalculate' action manually activates the system re-valuation of the copyright status. This action might be required since the system automatically calculates the copyright status only in two cases (request creation and fulfillment/un-fulfillment) but you may want to reflect the most updated copyright status in an intermediate step.

To do so, click Recalculate. The updated status will appear in the 'Change Copyright Status to' field. You can add a free-text note. If you want to proceed with the action, click **OK**. The manual update and the note (if it exists) are written to the request log transaction.

The 'Copyright Payment' section is enabled in the Copyright Management window of each filled request with a copyright status of '20 -Above the maximum number of free copies'.

The 'Copyright Payment' section includes the following fields:

- **Approval Number** – displays the approval number that is assigned to the copyright file of the request
- **Payment Status** – shows the payment status of the request

Upon fulfillment of a request, the initially assigned values for those fields are:

- Approval Number – left empty
- Payment Status - 'Not handled' (copyright payment procedure has not yet been concluded).

Both fields, Approval Number and Payment Status, can be processed by the 'Copyright Payment Report service' (ill-61). There is also an option to manually update these fields.

Each update of the copyrights status is written into the Request Log and can be viewed via the GUI-ILL Borrowing Request Log. This is especially important for manual copyright changes but also applies to changes made automatically by the system. In the case of a manual update/recalculate, the free note text (if it exists) also appears in the log.

For more details, see the Copyright – US Mode chapter in the *System Librarian's Guide- Integrated ILL*.

3.9 Sending Borrowing Requests to OCLC using Direct-to-Review

ILL Direct Request is a service that facilitates unmediated interlibrary loan. With Direct Request, ILL requests are created by an external source, and then sent to the OCLC Interlibrary Loan service. OCLC ILL is checking the requests against its suppliers file, and based on the Direct Request information can send the request to specific supplier.

Tracking the request status is then done by communication between OCLC ILL and the supplier. The external ILL system which initiated the request is not involved in the actual ILL process.

This is illustrated in the following diagram:

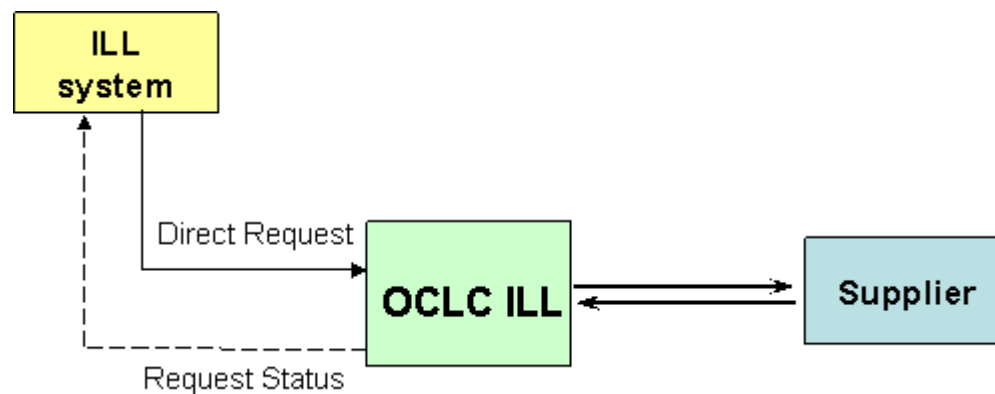

It is possible to send borrowing requests from Aleph ILL module to OCLC ILL using direct request (Direct-to-review). The requests that were sent to OCLC will be placed in the requesting institution's OCLC review file.

3.9.1 Defining OCLC Direct Supplier

An OCLC Direct supplier is defined as any other ILL partner (see section [2.1 Setting up ILL partners](#) on page 17). It can be a shared external partner or a non-shared external partner, depending on the library's policy.

The OCLC Direct Supplier must be set with the OCLC Direct protocol type.

Since the initial send to OCLC Direct supplier is done using an ISO message, the communication fields are required when the protocol type is OCLC Direct. However, the institution symbol field of the OCLC direct supplier is optional.

Note:

Since the OCLC symbol of the requesting institution is different than that of the regular institution symbol, it should be defined as an alias.

Due to a technical requirement of the OCLC direct service, the alias content is set in the “Institution” tag of the APDU.

3.9.2 Workflow for Borrowing Requests when Supplier is OCLC Direct

In general, the flow of the outgoing ILL request when the ILL partner is defined as OCLC Direct is a regular ILL flow. The operator uses the same interfaces to apply the exact same flow as for regular ISO ILL requests or for Letter requests. The major difference is that in the case of OCLC Direct Supplier, no messages are produced except in the initial send action. This is because the actual communication with the supplier is done inside OCLC. Manual status changes can be done inside Aleph ILL to reflect the status of the request inside OCLC. These changes are done by staff members and are under their responsibility.

Sending Requests to the OCLC Direct Supplier

When a request is sent to OCLC Direct supplier, an APDU message is sent, including all regular APDU tags, as happens when sending requests to suppliers with protocol-type = ISO. In addition, the following object is added to the responder-specific-service element of the ILL-Request APDU:

```
OCLCILLService DEFINITIONS ::=
    -- The object identifier for this EXTERNAL
    -- is 1.0.10161.4.1000.2.1

BEGIN

OCLCILLService ::= SEQUENCE {
    oCLCILLServiceType [0] IMPLICIT OCLCILLServiceType
}

OCLCILLServiceType ::= ENUMERATED {
    directToProfile (1),
    directToLender (2),
    directToReview (3)
}

END
```

Aleph always sends OCLCILLServiceType value 3 (directToReview).

More details about the responder-specific-service element can be found at:
<http://www.collectionscanada.gc.ca/iso/ill/regi4-1000-2-1.html>

Manual Status Changes

As described above, after the request is sent to the OCLC Direct supplier, it is handled inside the OCLC workflow.

It is the staff user's responsibility to reflect the status of the request in OCLC to Aleph ILL. (This is necessary so that patrons can review the request's status in the OPAC).

It is the library's decision on how accurate it wants to keep the status of the request in Aleph ILL. For example, some libraries might want to update the request when it is shipped, and others might update the status only when it is actually received in the library.

The Change Status options are defined in `./alephe/tab/tab_ill_change_status_out`.

Patron Updates of ILL Requests via the OPAC

Patrons can monitor their ILL requests from My Library Card in the Web OPAC. Since status changes are performed manually by staff user:

- Patrons are not able to renew OCLC Direct-to-review requests via the OPAC.
- Cancel of a request by patron is available only for requests that are not yet sent to the OCLC Direct supplier. (The status is either New, Waiting for process, or Locate failed).

4 Lending Requests

ILL lending (incoming) requests can be received in non-electronic format, by telephone, fax, e-mail, mail, and so on. These requests must be entered into the system for handling. Requests can also be received in electronic format, in the ISO protocol standard, or in the SLNP format in which case they enter the system without manual intervention.

In this section we explain the procedures and forms for entering requests into the system.

4.1 Creating an ILL Lending Request

There are two options for creating an ILL lending request:

- From the Lending menu
- From full record display in the Search tab

To create an ILL request from the Lending menu

1. Click the Lending menu, or press ALT + L. Then click the relevant button for you chosen format (serial or non-serial), for example, Create New Serial Lending Request:

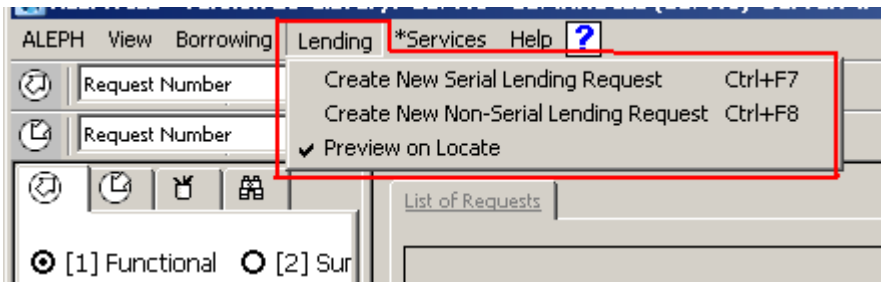

Or, click the button as the far right of the Borrowing bar (for Create New Serial Lending Request or Create New Non-Serial Lending Request):

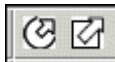

A form displays:

Note that slightly different forms display, depending on where you initiate the request (from the Borrowing Menu or from Full Record), and depending on the material type (Serial or Non-serial). The above is an example of a Serial form.

2. Complete the form, and click **Send**. You will be transferred to the Functional mode in the Lending tab, where you can continue handling the request, by initiating the Locate function.

To create a Lending request from the full record display in Search mode

1. After finding a relevant record, from the full bibliographic record display in the lower pane, click **ILL Request**:

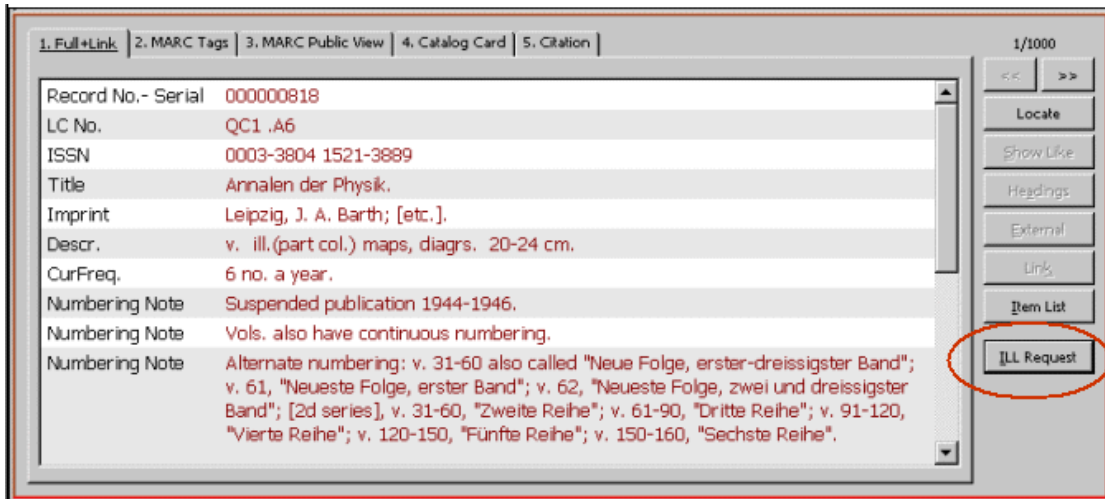

2. A pop-up window appears; choose Lending Request.

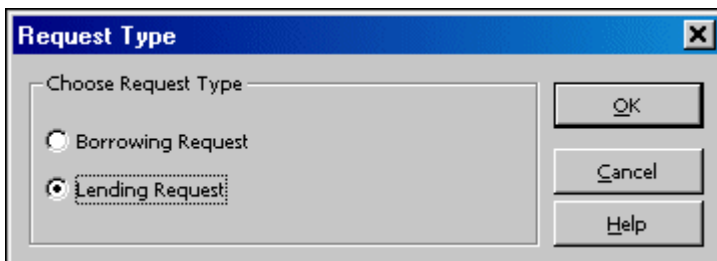

A Serial or Non-serial form pops up, with the bibliographic information displayed in the form. Here is an example of a non-serial form:

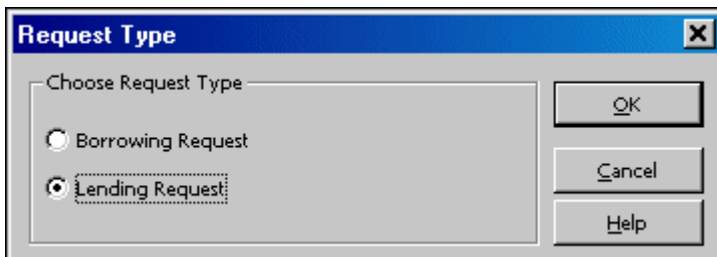

Note that slightly different forms display, depending on where you initiate the request (from Main Menu or from Full Record), and depending on the material type (Serial or Non-serial). When the request operation is initiated on the Full Record in Search mode, the bibliographic information displays, but cannot be updated; the Serial request includes fields for specifying volume and issue information.

3. Complete the form, and click **Send**. You will be transferred to the Functional mode in the Lending tab, where you can continue handling the request, by initiating the Locate function.

Processing lending requests

ILL Lending requests are registered in the system in the following ways:

- A request is received electronically from an ISO ILL partner and processed by the library's ILL daemon. If the request is accepted by the system, it is added to the bank of NEW or NEW MEDIATED requests. ISO partners must communicate requests through an ISO ILL Protocol message.

- A request is received electronically from the central ILL server and processed by the library's local SLNP server. If the request is accepted by the system, it is added with status AHP and a hold request is automatically placed for the item (if there is exactly one available item) or NEW (if there is more than one available item). SLNP partners must communicate requests through an SLNP protocol message. No further handling of the request is necessary until the material is shipped.
- A request is received in manual form from an ILL partner, and is manually uploaded by ILL staff. Requests cannot be manually uploaded for ISO partners. Refer to the section above for details on entering a request in the system.

Some of the steps in the Lending workflow are optional, and some of the steps in the process can be performed by the system in an unmediated manner. Therefore, the exact workflow of your library might match only some of the workflow steps described following.

Optional automatic processing can handle NEW and NEW MEDIATED requests for ILL Units that are configured for "Unmediated Locate". In this case, the system performs a 'Locate' action; that is, it attempts to identify a single matching title. Depending on ILL Unit configuration, the 'Locate' can also be set to include a check for relevant items. The result of this automatic processing depends on ILL Unit setup, and will conclude as follows:

If locate is successful, the system prepares a printout, which includes the request details, and the local bibliographic and item details; the request status is changed to "Located and Printed".

If locate finds more than one matching bibliographic record, the system prepares a printout, which includes the request details; the request status is changed to "Multiple Located and Printed". A future version might allow configuration that will change status to "Multiple Located", without any printout.

If locate is unsuccessful ("unsuccessful" can mean title not found, or, title found but no items found, depending on ILL Unit setup), the request status can change to "Mediated", or to "Answer Unfilled" (depending on ILL Unit setup); in the case of Answer Unfilled, a message is sent to the requester. This is a terminal status.

The following documentation assumes manual processing of ILL requests. All manual tasks related to lending workflow are performed in the Lending tab of the Integrated ILL GUI, and in the Services menu.

Lending requests are grouped for view by status in the Summary view of the Lending tab. The Summary mode of the tab provides an overview, a "table of contents" as it were, by request status, of the requests. This view acts as an index to the active ILL requests. The Summary view also displays Message groups, which are important for follow up.

Actions are performed in the Functional mode of the Lending tab. The workflow is described in stages, in the following sections in this chapter. Remember, after you create a lending request (from the Main Menu – Lending – Create New Request, or from Search – Full Display – ILL Request), the interface switches to the Lending tab in Functional mode, with the newly created request displayed, ready for action.

4.2 Handling new lending requests

The Lending workflow begins with the existence of a new lending request, created by the ILL daemon from an ISO ILL message, or by an ILL staff member in the Integrated ILL GUI, as described in [4.1 Creating an ILL Lending Request](#) on page 56 of this document.

These requests are initially assigned the status 'NEW' or 'NEW – STAFF REVIEW'. If a requester note has been registered in the request, the request is automatically assigned the review status.

If your processing is completely manual, you will begin processing new requests by choosing the 'NEW' and 'NEW – STAFF REVIEW' requests.

There are various options available for automatic processing, all of which affect how you begin processing Lending requests. The options include the following possible scenarios:

NEW and NEW – STAFF REVIEW requests are printed in slip and/or report format at regular intervals, using the ill-65 batch service, and the request status does not change.

NEW requests are submitted to a 'Print' process in an ongoing manner, and the request status changes to 'New and Printed'.

NEW requests are submitted to a 'Locate and Print' process, in an ongoing manner, and, if matched, the request status changes to 'Located and Printed'. You can assume that call slips have been printed for these requests, and they are being handled from the slips, rather than from the status node in the Summary view.

Mediated requests include a requester note; or depending on the setup of your ILL Unit, requests for which a match was not found.

The following explanation of the workflow assumes that no automatic processing or printing is being performed, and that the workflow commences with the New and New – Staff Review status nodes in the Summary view.

To view new requests

1. Open the Lending tab (click the tab or press **F6**) and choose Summary mode. This is the starting-place for handling requests.

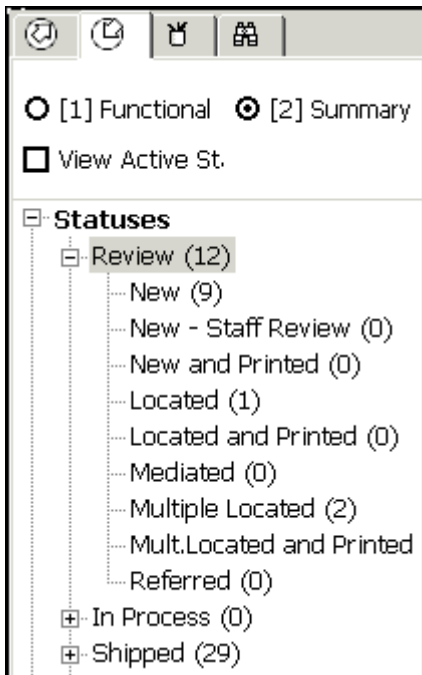

From here, you can choose a status category or message group, select the requests, and move them into the Functional mode, for action.

Refer to [1.2.1 Screen elements](#) on page [10](#) above for an explanation of the Summary mode and how to work with it.

2. Click a folder to display summary information, and to select requests for processing.

You can choose a Status Display group from the drop-down list. The list can be grouped by

- Requester ID
- Open Date
- Last Activity Date
- Shipment Method

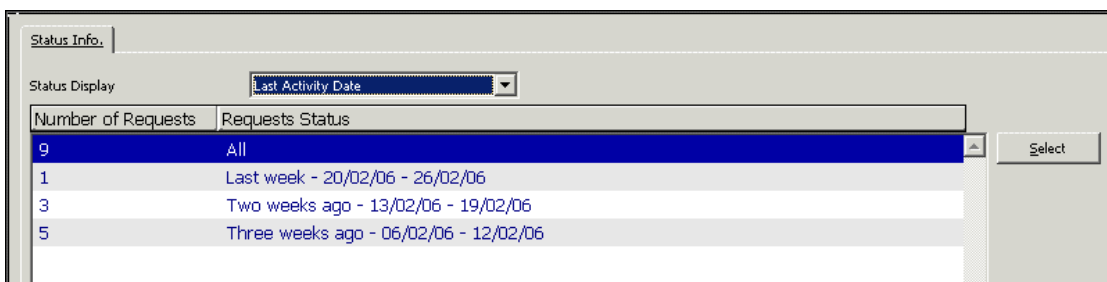

3. To work on a group of requests, highlight a line to select it, and click **Select**, or double-click the line. The Lending tab changes to Functional mode, where requests can be processed and actions can be taken. The group of requests that was chosen in the Summary mode displays in a list, with full information (for view and update) displaying in the lower pane.

Following is an illustration of the Integrated ILL GUI after a group of NEW requests was chosen from the Summary mode.

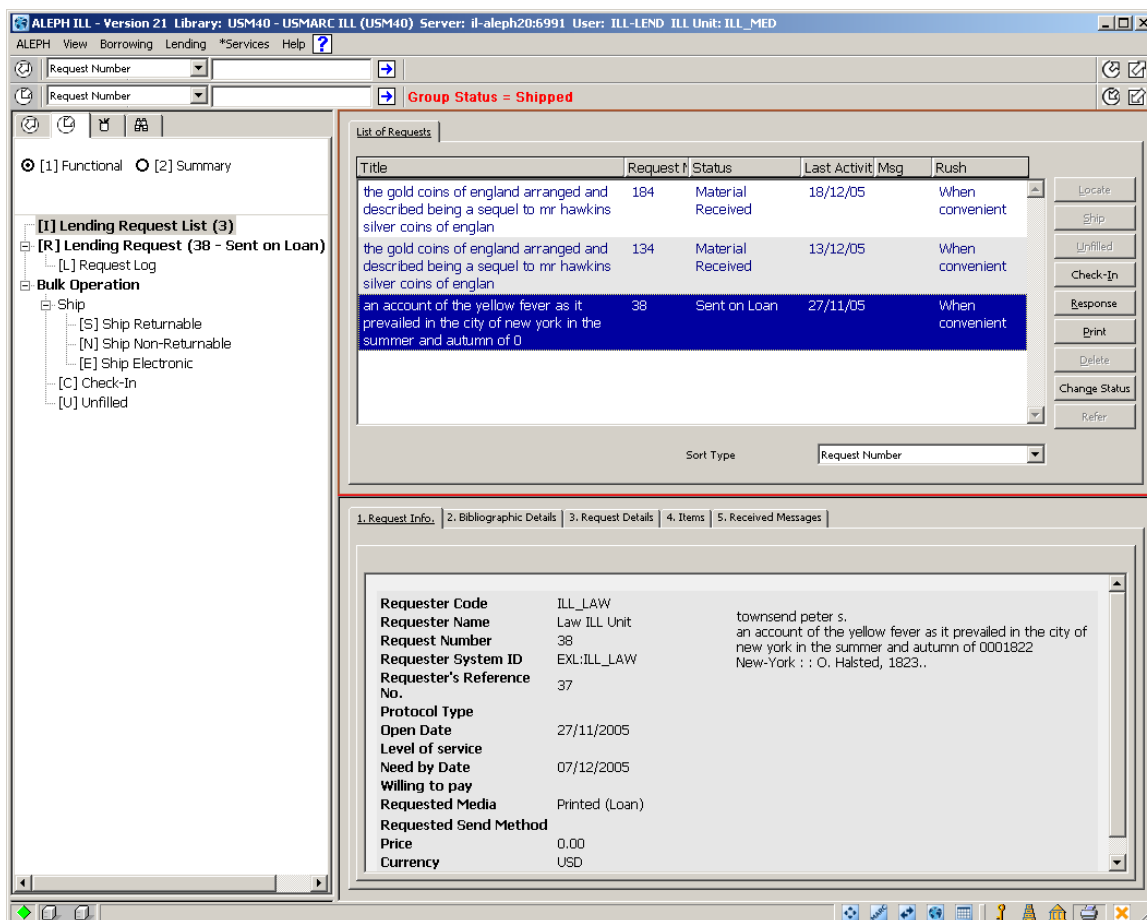

The nodes in the Functional mode of the Lending tab are “Lending Request List” (with a display of the count of the number of requests in the list), “Lending Request” (with a display of the request number and status of the request currently highlighted in the list), and sub-node “Request Log” (for displaying the log of the request). The Bulk Operation nodes do not concern us at this point.

- To work with a request, select it in the upper pane. The request information displays in the lower pane in the first tab, for view only; the action buttons relevant for a new request are located to the right of the list in the upper pane. Additional action buttons are located in the tabs in the lower pane.

4.2.1 Locating new requests

The first task when dealing with new requests is to identify the bibliographic record in your catalog. If you created the request from the Search tab, you have already identified the record, and therefore you should skip the **Locate** action, and proceed to the next step.

Click the **Locate** button to initiate searching for the requested title in your catalog.

You can display a “Locate Preview” window to review the “locate” process.

To preview the Locate process:

From the Lending menu, select “Preview on Locate”:

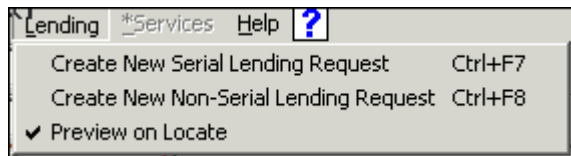

When you click the **Locate** button, the Locate Preview window displays:

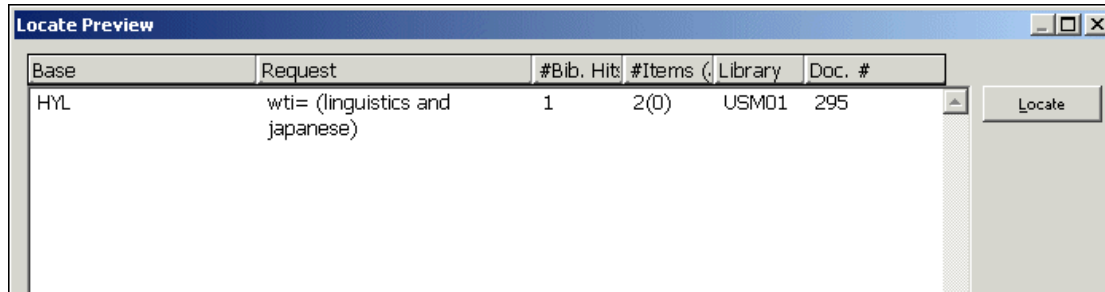

The Locate Preview window shows you the search query and the result of the Locate process. The list shows the code of the catalog base that is checked, the search query, and, the number of matching bibliographic records found, the number of relevant item records found, the code of the catalog that is checked, and the system number of the identified bibliographic record.

To complete the process, click **Locate** in the Locate Preview window. If you do not want to perform the Locate action at this time, click **Cancel**.

The possible outcomes of the **Locate** action are:

- **Unsuccessful Locate** - If the Locate does not succeed in finding a bibliographic record, or finds a bibliographic record, but does not find relevant items, the request status changes to “Answer Unfilled” or “Mediated” (depending on your Unit’s configuration). When the status changes to “Answer Unfilled”, the requester is automatically notified (by ISO ILL message or by letter). This is a terminal state. When the status changes to “Mediated”, you will perform a manual search.
- **Successful Locate** - When the Locate is successful, the status of the request is changed to "Located".
- **Multiple Locate** - If the Locate finds more than one matching bibliographic record, the request status changes to "Multiple Located", and the Multi Locate Preview window immediately displays, as in the following example.

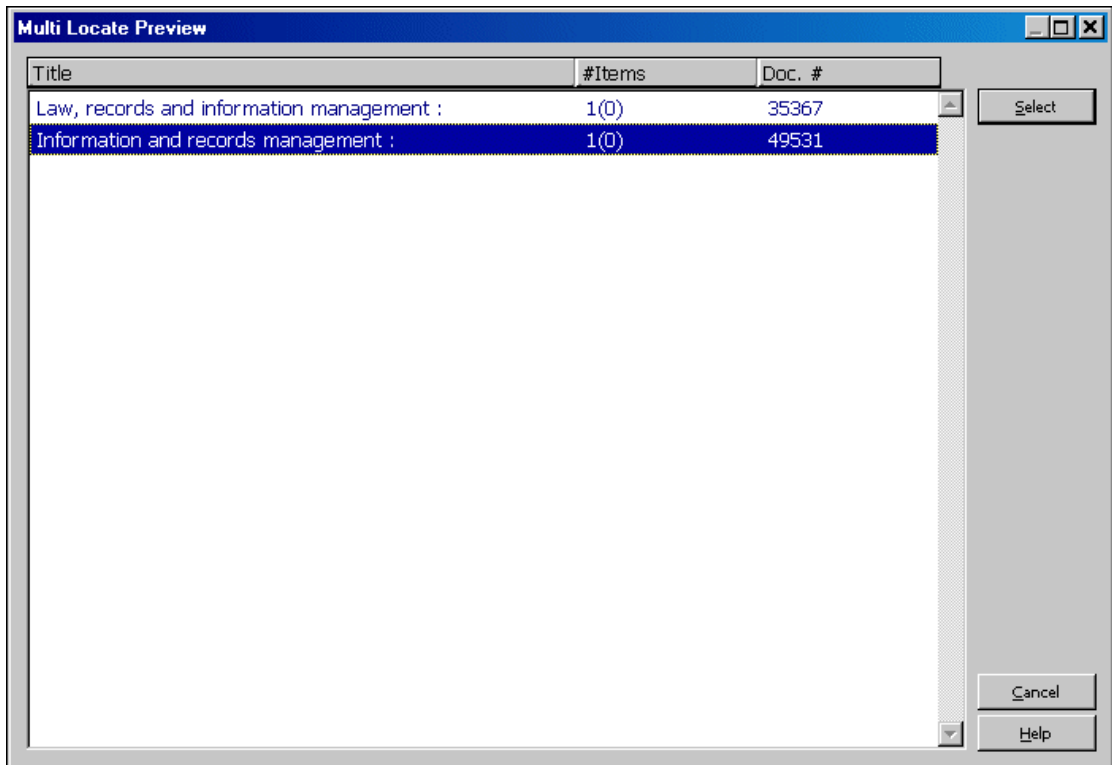

To print the list that displays, click anywhere in the list, and press F11. If, when looking at the list, you are able to identify the record that matches the request, highlight the line and click **Select**. This changes the request status to “Located”. If you are unable to identify a record that matches the request, click **Cancel**. The request status will remain “Multiple Located”. At this point, you might decide to print the request details (by clicking the **Print** button on the List of Requests), or you might leave this request to be handled later, from the Review – Multiple Located node in the Summary mode.

4.2.2 Identifying a requested item (optional)

After the locate action has assigned a matching bibliographic record from your catalog, you might now want to ascertain whether there is an available item on the shelf. This stage is optional, as you might prefer to check the shelf directly. For example, if the request is for a journal article, and your library’s catalog does not include full holdings information, you might have no choice but to check the shelf directly.

If you want to check item availability before continuing, you can view this information in the Items tab of the lower pane List of Requests display.

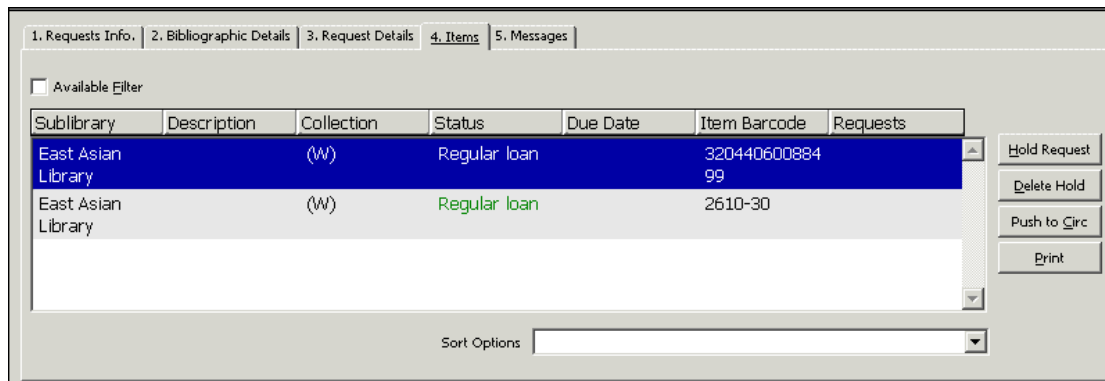

To	Do this
Print a call slip	Click Print .
Display only available items	Select the Available Filter check box; leaving it clear displays all items.
Place a hold request for the requester	Click Hold Request ; this triggers sending a “hold placed” message to the requester.yifat123
Transfer a record to the Items tab in the Circulation module	Click Push to Circ . Depending on your authorization, you can view fuller information and/or perform Circulation actions on the record.

4.2.3 Printing call slips

In order to supply a request, you will want to print call slips.

There are several ways to print call slips:

- Manually - Open the Items tab in the List of Requests lower pane, and click Print. This triggers the printing of a form with details of the request, and bibliographic and item information.
- Running an automatic process which performs Locate; call slips are printed as part of the process.
- Submitting a batch service which prints slips for Located requests, at set intervals.

4.2.4 Sending a response

To send a response

From the List of Requests, select a request line and click **Response**.

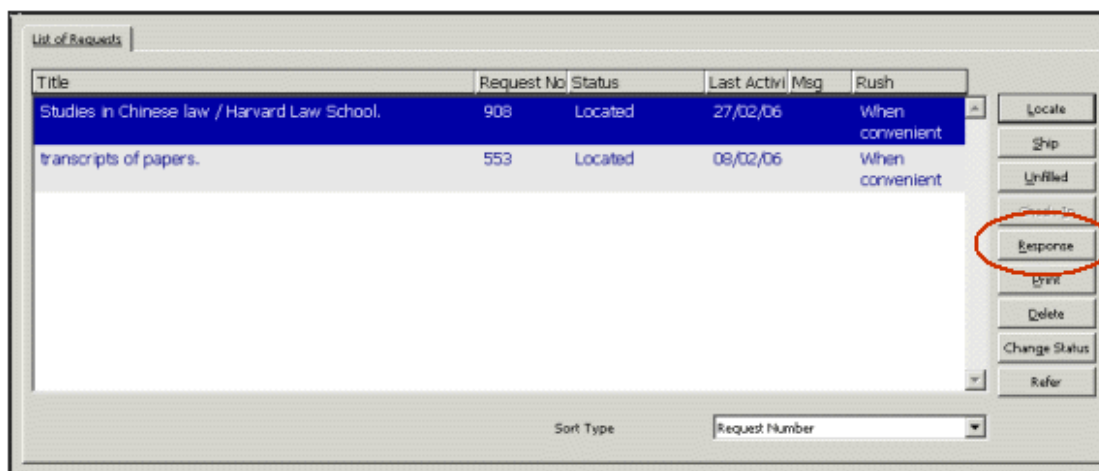

A window pops up, for setting the message type and content.

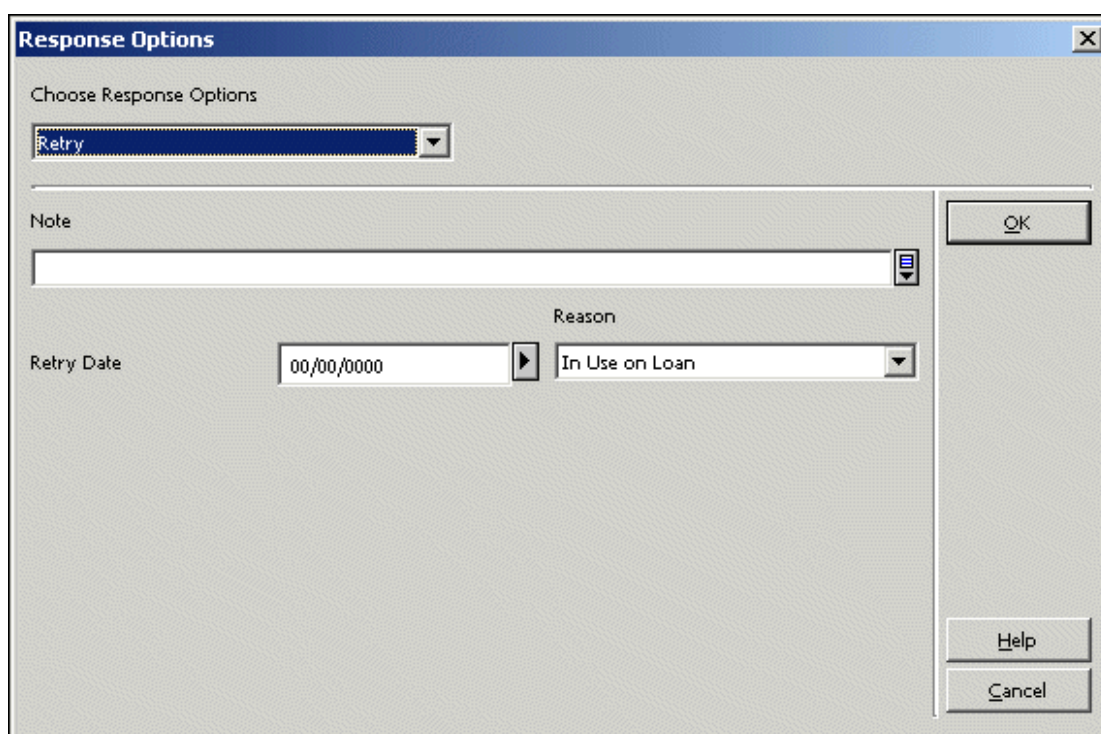

The fields displayed in the lower portion of the pop-up window change to suit the chosen message option.

If material can be supplied, but there are restrictions, in the Response Options window, choose one of the following response options:

- Message — You must type in message text in the Note field.
- Conditional — You are willing to supply, under certain conditions, which should be stated in the Note field.
- Retry — You suggest that the requester try again at a later date. You must fill in an estimated supply date, and choose a reason for the delay from the drop-down list.
- Locations — You are unable to supply the material, and you are suggesting an alternative supplier.

- **Hold Placed** — You are unable to supply at this time because the material is on loan, and you have placed a Hold request so that it will be trapped when checked in. You must fill in an estimated supply date.
- **Estimate** — Similar to Conditional – you are willing to supply, but there is a cost involved. You must fill in the estimated cost.

To	Do this
Inform the requester that the material will be supplied, prior to actually shipping material	<ol style="list-style-type: none"> 1. From the List of Requests, select a request line and click Response. This displays the Response Options window. 2. Send a Will Supply message. This triggers the dispatch of an ISO ILL message or a letter, depending on how you communicate with the requester.
Inform the requester that you are unable to send the requested material immediately, or that there are restrictions on supplying the request	From the List of Requests, select a request line and click Response . This displays the Response Options window.
Place a hold request for the requester	Click Hold Request ; this triggers sending a “hold placed” message to the requester.
Transfer a record to the Items tab in the Circulation module	<p>Click Push to Circ.</p> <p>Depending on your authorization, you can view fuller information and/or perform Circulation actions on the record.</p>

4.2.5 Reporting that material cannot be supplied

If you are unable to supply the requested material, you will either want to report “Answer Unfilled”, or, if supported by your organization, might want to **refer** the request to another supplier. Referral is described in section [4.2.6 Referring a request to another supplier](#) on page [69](#).

There are two ways to send an Unfilled message:

- Select a single request in the List of Requests pane and click the **Unfilled** button, or
- In the left Navigation Tree, under Bulk Operation, choose Unfilled.

If you are working from printed lists or slips, it is more efficient to report Unfilled requests in bulk.

To send an Unfilled message (single)

1. Select the request in the List of Requests, and click Unfilled:

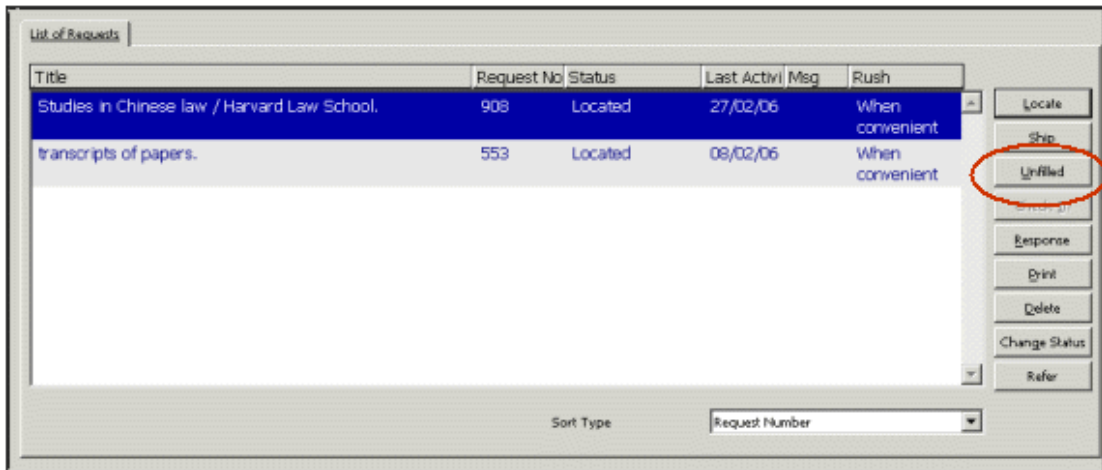

The Unfilled window displays.

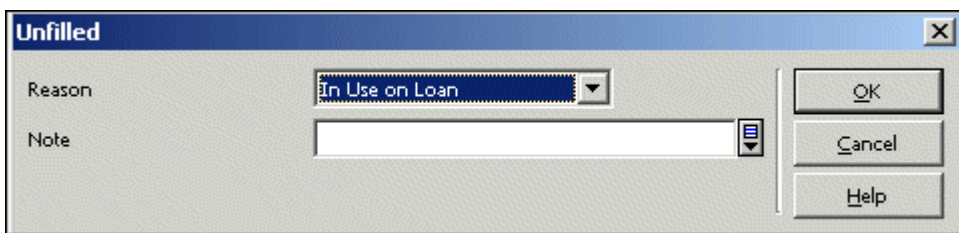

2. Select the reason from the drop-down list, optionally add a note, and click OK.

To send an Unfilled message (bulk)

1. In the Navigation Tree, select the Bulk Operation – Unfilled node:

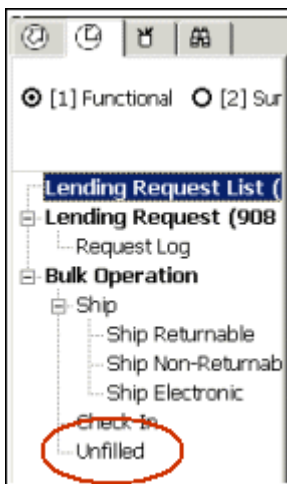

The right pane displays a fill-in form.

2. Choose the reason for your inability to supply the request from the drop-down list, enter the request number and click Send. The request details display in the lower portion of the pane.

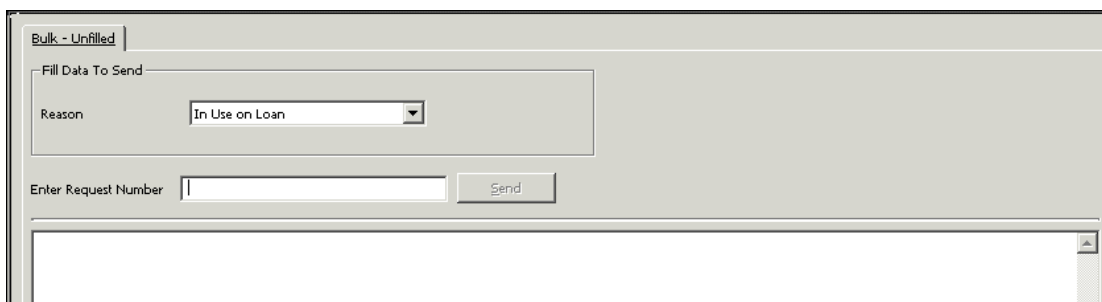

4.2.6 Referring a request to another supplier

If you are unable to supply requested material, your organization might want to refer the request to another supplier.

To refer a request to another supplier

From the List of Requests, select a request line and click **Refer**. The display of the **Refer** button is dependent on a system flag definition.

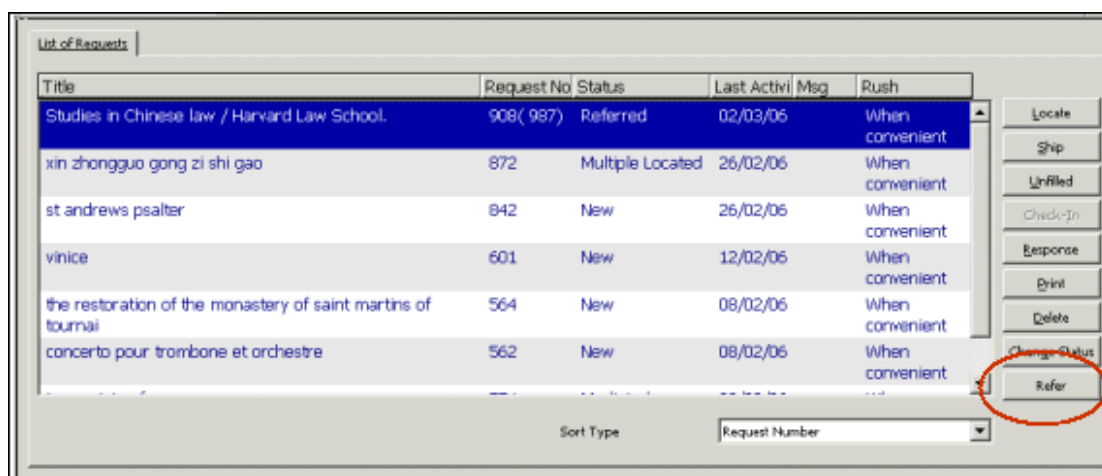

This causes your ILL Unit to become a mediator between the requesting library and another possible supplier.

This action creates a new borrowing request, identical to the lending request, placed by you on behalf of the requester. It has the following values:

- The requester ID is copied from the original requester ID
- The pickup location is always REF
- The request status is NEW
- The requested service level is copied from the lending request. If no service level was registered in the lending request, the 'when convenient' level is assigned.

The 'Request Number' column in the List of Requests displays the number of the linked request in parentheses, both in the Lending List of Requests and in the Borrowing List of Requests.

The new request is handled in the Borrowing environment.

4.2.7 Shipping material

When the material is at hand, ready for shipping, you use the **Ship** function to send a “Shipped” message to the requester and to update the request’s status to “SHIPPED”. There are different scenarios for performing the **Ship** action, depending on whether you are sending a Returnable, a Non-Returnable, or an Electronic copy, and depending on whether you choose to initiate shipping on a single request, or on a group of requests. If you are working from printed lists or slips, it is more efficient to report Shipped in Bulk Operation.

To send a Shipped message for a single request

1. Select the request’s line in the List of Requests, and click Ship:

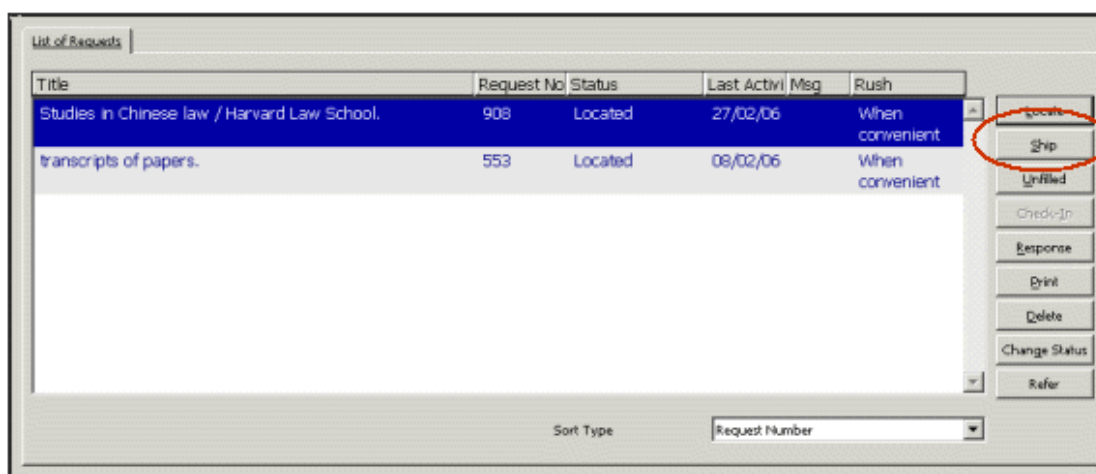

A window pops up, enabling you to determine that the material is Returnable, Non-Returnable or Electronic.

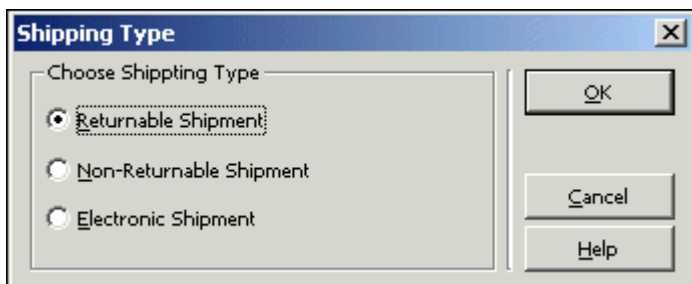

2. Choose the Shipping Type, and click OK. A fill-in form displays. The fields shown vary, according to the chosen shipping type. Here is a form for Returnable Shipment:

3. To send the SHIPPED message, fill in the fields and click **OK**.

To send a Shipped message for multiple requests

In the Navigation Tree, select a **Bulk Operation** – Ship Returnable, Ship Non-Returnable or Ship Electronic node:

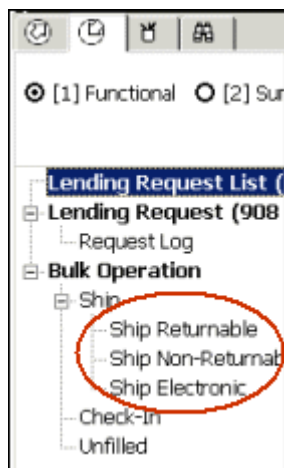

The right pane displays a fill-in form. Fill in the form (which differs slightly, depending on whether Returnable, Non-Returnable or Electronic was chosen). Here is a form for Returnable Shipment:

Enter the request number and click **Send**. The request details display in the lower portion of the pane.

4.2.8 Requests – optional actions – printing, deleting, changing statuses

To	Do this
Prepare a printout of request details for internal use.	From the List of Requests, select a request and click Print .
Remove a request	From the List of Requests, select a request and click Delete . The system checks the current status of the request and deletion will only take place if the status allows deletion. In some cases, you might have to change the status to CLOSED, after which you can delete.
Change a request's status	<p>From the List of Requests, select a request and click Change Status. If Change Status is allowed, a window pops up, with the possible new statuses in a drop-down list. You can also enter a note, which is registered in the Request Log.</p> <p>The changes that are allowed are controlled by your system librarian; not all changes are allowed.</p>

4.3 Following up lending requests

You can follow up requests in three ways:

- Viewing the different messages from the requester in the Messages node from the Lending tab's Navigation Tree in Summary mode (only relevant for ISO ILL users)
- Viewing the different request statuses in the Statuses node from the Lending tab's Navigation Tree in Summary mode
- Running status-related batch services/reports - Lending Library Overdue Handling (ill-68)

4.3.1 Handling messages in the Messages node

The Messages node includes messages received via the ISO ILL Protocol. These messages automatically enter the system, and therefore must be reviewed here. For example, a requester may send you a message requesting "Renew", or may inform you that material is damaged, or may request that you cancel a request.

Non-ISO ILL partners will communicate messages directly (by fax, e-mail, letter, and so on). Messages that are received in a manual manner can be registered in the request log; they are not reflected in the Messages node.

ISO ILL Electronic Messages

Messages that are received from ILL partners through the ISO ILL Protocol are automatically registered in the system. In some cases these messages change the status of the request.

The message nodes display the following ISO ILL message types:

ISO ILL message type	Description
General Message	These are messages of a general nature.
Cancel	These are requests to cancel a previously sent request.
Request for Renew	These are requests to lengthen the loan period for a particular item.
Status Query	This is a message for consistency checking; it is automatically replied to by the system.
Status or Error Report	This is a system message for cases where a message does not conform to the ISO standard.

The number in parentheses on the Messages nodes represents the number of messages of this type.

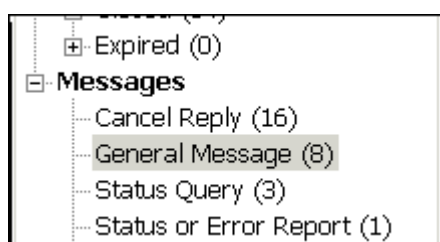

Choose a Message node in order to display and work with the requests and the messages:



The upper section of the Messages pane displays active messages. A message is active until it is “dismissed” by a staff user; it can be dismissed in either the Summary mode

or the Functional mode. A dismissed message can be reactivated in the Functional mode.

When you choose a line in the list, request information and significant messages that have been received for the request, (both active and dismissed), display in the tabs of the lower pane.

To remove a request from the messages view, click **Dismiss**. The message remains registered and viewable when a single request displays in the Functional mode.

To send a responding message to the supplier, click **Message**. The **Message** button is active only for General messages.

In addition to providing message information, the Messages node allows you to handle highlighted requests for which messages have been received by clicking **Select** or **Select All**. This moves the requests and the interface to the Functional mode, where you can send a **Response** to the message.

Manual messages

Your ILL Partner might send you a message concerning his request, such as a request for renewal, or to notify that the material has been lost. You can update the request status, register the message in the log, and/or send a response to the message.

To respond to a message

1. From the List of Requests, click **Response**.

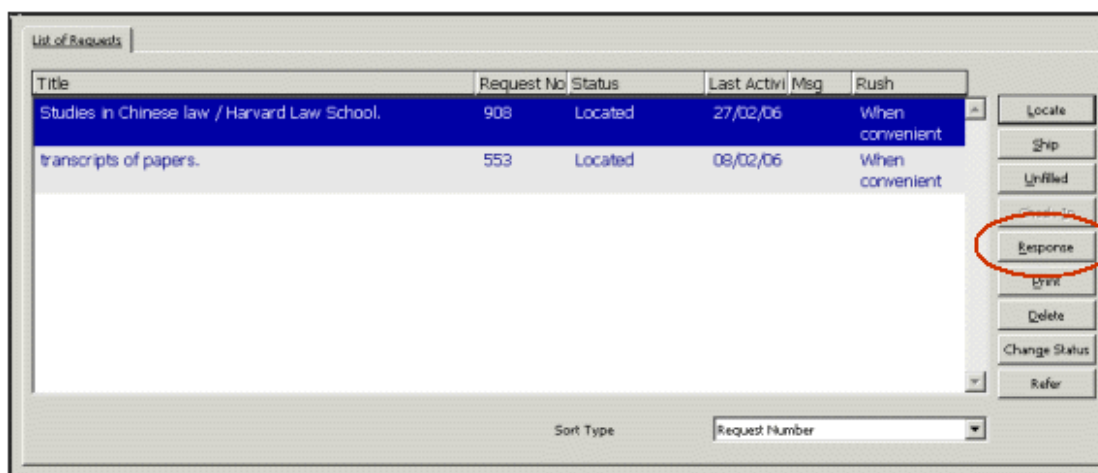

If communication with the ILL partner is ISO ILL, an APDU message is sent. Otherwise, a file is created for dispatch by e-mail, or for printing.

A window pops up, for setting the message type and content. The fields displayed in lower portion of the window change to suit the chosen message option.

The message types are:

- Message; you must type in message text in the Note field
- Recall
- Overdue
- Renew Answer

2. Fill in the fields and click **OK**. The response is registered in the request's log.

4.3.2 Viewing lending requests' statuses

The Statuses node shows the statuses of all incoming requests in the system. Pay particular attention to the "Answer Will-Supply" and "Answer Hold-Placed" statuses, in order to verify that requests have not been sitting in this status for too long. The "Answer - Will Supply" status should become "Shipped", and the "Answer Hold-Placed" status should become "Will Supply" or "Shipped" within a reasonable period of time.

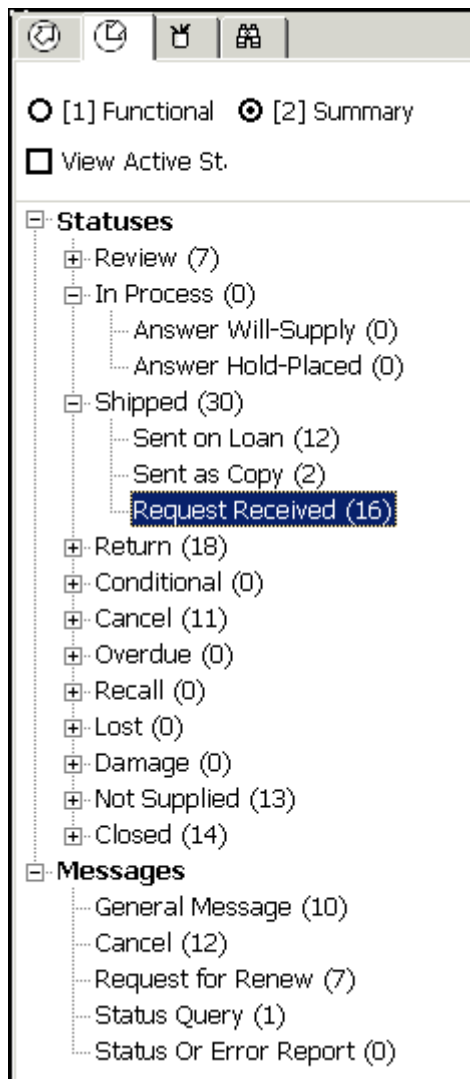

4.3.3 Running the overdue loans services / reports

The Lending Library Overdue Handling (ill-68) service retrieves requests for which the expected return date is earlier than the current date. The request's status is changed to 'Overdue' and a log entry 'Overdue Message Successfully Sent' is written.

To access this service, from the **Services** menu, point to **ILL Lending** and click **Lending Library Overdue Handling (ill-68)**.

4.4 Checking in returnable material

Checking in returned (Returnable) material completes the lending cycle. Check-in triggers the update of the request status to 'Closed', and performs check-in of the material within the Circulation system.

You can check in material from a List of Requests, for a single request; through the Navigation Tree's Bulk Operation – Check-in node; or in regular check-in procedures in the Circulation module.

To perform check-In for a single request

In the List of Requests, select the request's line and click **Check-In**:

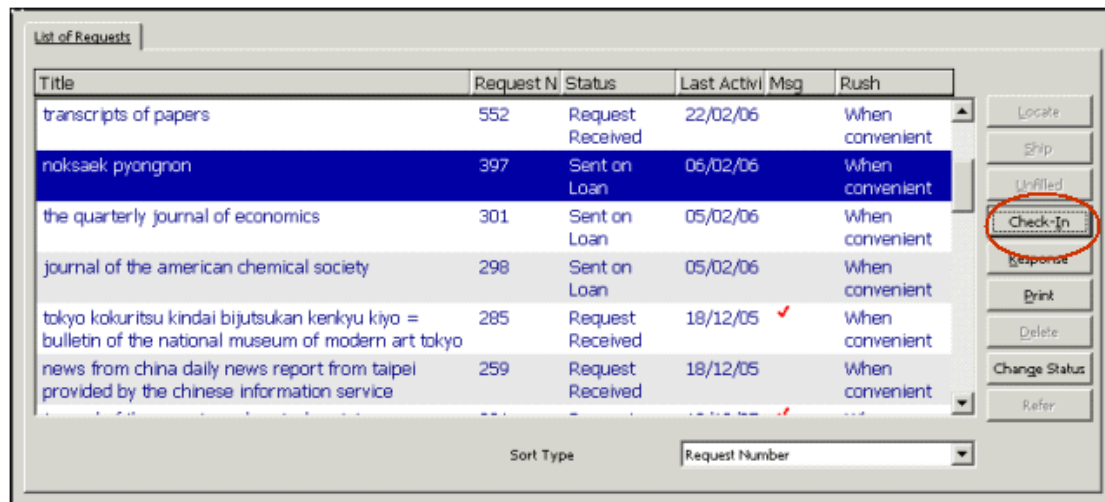

A window pops up, in which you can enter a note.

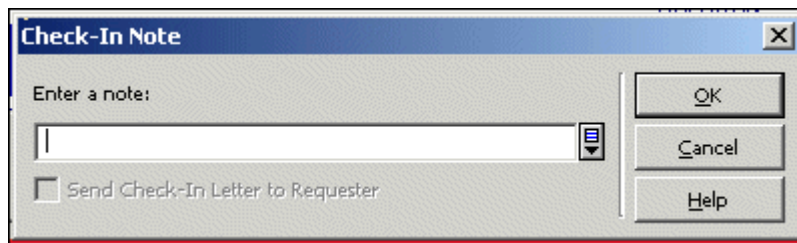

If you want to inform the requester that you have received the material, and communication with the ILL partner is not ISO ILL, select the "Send Check-In Letter to Requester" check box. If communication is ISO ILL, a message is always sent.

To complete check-in, click **OK**. The request's status is updated to CLOSED.

To perform check-In for multiple requests

In the Navigation Tree, select the **Bulk Operation – Check-In** node. The right pane displays a check-in form:

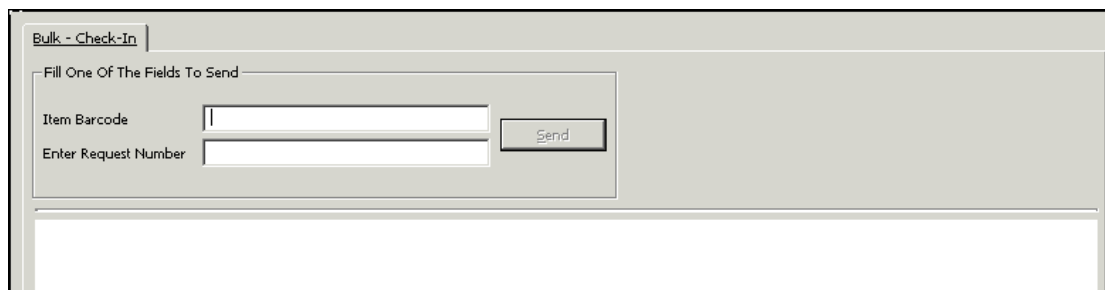

This window is used for checking-in returnable material.

Enter the **Item barcode** or the **Request Number** and click **Send** to complete the operation. The status of the request is updated, and request details display in the lower section of the pane.

Check-In changes the request status to CLOSED and performs check-in for Circulation as well. If you use ISO ILL Protocol to communicate with the supplier, notification is sent to the requester.

5 The ILL Request Log

The system can record a log of request-related activities that have occurred for borrowing and lending requests. The Request Log node is available via the Request Log node of the GUI-ILL functional mode.

For library that uses the ISO-ILL protocol: All ISO messages that are sent and received are recorded in the ILL request Log:

The screenshot displays two windows from the GUI-ILL system. The top window, titled 'List of Logs', contains a list of log categories with checkboxes: All (checked), General (Manual log), Message to Supplier (Manual log), Supplier Response (Manual log), ILL Request Created, Supplier Request Created, and Letter was Sent to the Patron. Below this is a table with columns: Date/Time, Description, System note, User note, User, and Action date. The table contains three entries, with the second one highlighted in blue. To the right of the table are 'Add' and 'Remove A, Date' buttons. The bottom window, titled 'Request Log', has input fields for 'Action Date' (00/00/0000), 'Transaction Type' (10), 'System Note' (Patron Request Status changed to Waiting for Process), and 'User Note'. It also features 'Update' and 'Cancel' buttons.

Date/Time	Description	System note	User note	User	Action date
07/05/06 12:16	Patron Request Status Changed	Patron Request Status changed to Sent to supplier		LEO_LT	-----
07/05/06 12:16	Patron Request Status Changed	Patron Request Status changed to Waiting for Process		LEO_LT	-----
07/05/06 12:16	ILL Request Created	ILL Request Number 866 created		LEO_LT	-----

Most of the transaction log is system-driven (as defined in your system's setup) but you can also enter a manual log. For more details, refer to the GUI-ILL Online Help.

6 ILL History Procedure

The ILL History procedure enables archiving old 'inactive' ILL borrowing and lending requests.

There are two batch services that support this procedure (both are avail from GUI-ILL-Services menu-Archiving):

Generate Borrowing History (ill-88) – Enables archiving borrowing requests whose status is one of the following: Cancelled, Closed, Deleted, Expired, or Unfilled.

Generate Lending History (ill-89) – Enables archiving lending requests whose status is one of the following: Cancelled by Requester, Closed, Deleted, Expired, or Answer Unfilled.

These services allow running the procedures for all 'inactive' requests or for specific statuses. In addition, the users have to fill in the 'Status Date Before' parameters so that only requests whose status date is before the quoted date (inclusive) are collected by ill-88/89.

An example of the Generate Borrowing History (ill-88) service form:

The screenshot shows a web form titled "Generate Borrowing History (ill-88) - USM40". The form is organized into several sections. At the top left, there is a text input field for "* Output File" containing "bor_history_2007". Below this is a section for "Borrowing Req Status" with a list of checkboxes: "All" (checked), "Cancelled", "Closed", "Deleted", "Expired", and "Unfilled". To the right of this section are buttons for "Submit", "View History", "Cancel", and "Help". Below the status section is a text input field for "Status Date Before" containing "30/06/2007". Underneath that is a dropdown menu for "Report Format" set to "Standard". A horizontal line separates the top section from the bottom section. The bottom section contains several dropdown menus: "Runtime" (Today), "At" (O'clock), "Library" (USM40), "Print ID", and "Report Language". On the right side of the bottom section, there are two checkboxes: "Add to History" (checked) and "Print To ADM Lib" (unchecked).

ILL Requests that are handled by Generate Borrowing History (ill-88) and Generate Lending History (ill-89) services are considered 'history records'. All requests related records remain attached to the requests so that all request information is kept (BIB records, request to suppliers, copyright records, request logs, etc.).

If a request has an attached open cash transaction (cash transactions that are not Closed or Waived), it will not be archived by ill-88/89 services.

The history requests are retained in their original ILL Library (XXX40). Each request that is archived will be updated with a request log that records the archive action.

Retrieving ILL History Requests via GUI

History request are not displayed in the GUI ILL regular view. However, they can be called by using one of the options below of the GUI-ILL-Borrowing/Lending Search Bar:

- Search by 'Request number'
- Search by 'Words from Title' (history) –Retrieval by words in the title of the “history” requests; this search will only cover history records.

Batch services for History Records

History request will be taken into account by the following batch services:

- Borrowing Library Statistic Report (ill-63)
- Lending Library Statistic Report (ill-64)
- Patron Link Removal (ill-70)
- Remove Patron IDs (cir-32)

The above services will be executed over the full scope of the request (active and history requests). All other batch services ignore the history records.

7 GUI ILL Services

The ILL services are accessed via the Services menu.

Each service is identified in the Batch Log and Batch Queue by its procedure name.

7.1 Borrowing Services

7.1.1 Borrowing Library Statistic Report (ill-63)

This service produces a statistics report for the borrowing library. The statistics report includes the following information:

- Supplier code.
- Total no. of requests - Requests that have been sent to a supplier.
- No. of pending requests - Requests that have been sent to a supplier or shipped but have not arrived yet.
- No. of canceled requests - Requests that have been sent to a supplier and canceled.
- No. of unsupplied requests - Requests that have been sent to a supplier and have received the response 'Unfilled'.
- No. of filled requests.
- Percentage of filled requests.
- Average number of days for filling the requests - Number of days from the time the request is made until it is shipped.
- Average number of days for shipping the request - Number of days from the time the request is shipped until it is received by the requester.

- Average number of days for returning the request - Number of days from the time the request is returned from the requester until it is checked in by the lending library.

Note: The Average number columns are not supported for NON-ISO partners. If no ISO partners exist in the system, it is recommended to remove those columns from the XSL template.

7.1.2 ILL Request Report (ill-74)

This service creates a report of all ILL borrowing requests made by a particular patron and/or requests made after a particular date.

7.1.3 Static Status Requests Report (ill-66)

This service produces a report of ILL outstanding requests whose status has not changed within the number of days you define.

7.1.4 Outstanding Requests of Former Patrons (ill-67)

This service produces a report of all outstanding requests (active requests) made by patrons whose home library privileges have expired. If the patron has no home library defined, the system checks the patron's ADM library privileges. Outstanding requests include ILL requests that have not yet been filled and ILL requests that have been filled but without the associated items having been returned to the ILL supplier.

7.1.5 Claim Report and Letters (ill-73)

This service creates a report of all ILL requests that have not been received up to the date expected (the requests have the status Sent to Supplier). You can also choose to print a letter to the supplier for each outstanding ILL request.

7.1.6 Send Requests to the British Library (ill-75)

This service searches for ILL requests to the British Library in the BL format whose status is NEB (New-ready for BL) and enables you to send an ARTEmail message to the British Library. The ARTEmail message contains a list of ILL requests.

The patron's address will be quoted below in the request only if ADD (Alternative Document Delivery) has been selected as one of the request's keywords. ADD is not a British Library keyword and will not be placed in the ART transmission. It is an ALEPH internal keyword whose purpose is to indicate that the patron's address should be displayed with the requested item in the ART transmission.

The patron's e-mail address will be quoted below in the request only if ADD and SED* have been selected as the request's keywords.

The templates for this function are located in the ILL library's (XXX40) form_<lng> directory with the text string "bldsc".

For each request format (ALEPH tag 592), there is a template for the ART message in the following manner:

- For format SE (Serial) which is a loan request, the form ill-print-bldsc-l-se-00 is used.
- For SE non-returnable request (copy or electronic), the form ill-print-bldsc-c-se-00 is used.
- For format CF (Conference) which is a loan request, the form ill-print-bldsc-l-cf-00 is used.
- For CF non-returnable request (copy or electronic), the form ill-print-bldsc-c-cf-00 is used.
- For formats that has no matching forms, the forms ill-print-bldsc-l-other-00 and ill-print-bldsc-c-other-00, are used.

This service is identified in the Batch Log and Batch Queue as p_ill_75

7.1.7 ILL - Hold Shelf List (ill-76)

This report lists all borrowing ILL requests that have been provided on the hold shelf, but have not been picked up by the patron. This report produces a list only, no status is changed.

7.1.8 Send Requests to a supplier service (ill-10)

This service searches for ILL requests whose request to supplier status is “Waiting for Process” (WAP) and sends them to the supplier. For suppliers whose protocol type is “Letter”, a letter is produced as a printout of this service. The status of the requests is changed to “Sent to Supplier” or to “Daemon Send Failed”, according to success or failure of the send action.

Note that this batch job is similar to the UE_19 daemon’s behavior, except of the locate part.

7.2 Lending Services

7.2.1 Lending Library Statistic Report (ill-64)

This service produces a statistics report for the lending library.

The statistics report includes the following information:

- Requester ID.
- Total no. of requests.
- No. of pending requests - Requests that have not been shipped.
- No. of canceled requests - Requests that have been canceled.
- No. of unsupplied requests - Requests that have been answered with Unfilled.
- No. of filled requests - Requests that were shipped.
- Percentage of filled requests.

- Average number of days for filling the requests - Number of days from the time an incoming request is made until it is answered with a SHP message.
- Average number of days for shipping the request - Number of days from the time the request is shipped until it is received by the requester.
- Average number of days for returning the request - Number of days from the time the request is returned from the requester until it is checked in by the lending library.

7.2.2 Overdue Handling (ill-68)

This service retrieves all lending requests which were already supplied and whose status is either 'Sent as Loan', 'Received by Requester', 'Shipped', or 'Recalled'. The ill-68 service checks the expected return date of the retrieved requests. If the request's expected return date is earlier than the 'Expected Return Date' that is defined in the service form, the system reports the request and produces overdue letters or ISO overdue messages to the requester (borrowing library).

When the system succeeds in sending the overdue message or letter, the request status is changed to 'Overdue' and it is reported in the Overdue Statistics Report as 'Overdue Message Successfully Sent'.

For ISO APDU OVERDUE messages only: When the system fails to send the overdue message, the request status is not changed and it is reported as 'Overdue Message Failed'.

You may activate this service to produce an overdue report only (without producing letters or ISO messages to the requesters).

The service produces two types of reports:

- **Overdue Summary** (form: overdue-apdu-report-total) – This reports the total number of overdue messages successfully sent to the requesters and the total number of overdue messages that failed.
- **Overdue Statistics Report** (form: overdue-apdu-report-body) – This report produces a slip for each requester unit.

The report shows the number of successful and failed overdue messages. It also shows details for each request that has been detected as overdue and shows whether or not the APDU message has been successfully sent.

7.2.3 Expired Messages (ill-69) – For ISO-ILL only

This service tracks lending Requests whose expiry date has already passed and which have not been shipped or answered to requester (requests with status: New, New-Staff Review, Located, Multiple Located, Located and Printed).

The ill-69 service sends APDU expired messages for these requests and changes the request's status to Expired.

Only requests which are managed by the ILL unit to which you are logged in will be handled by this service.

7.2.4 Lending Library - ILL Requests Report and Slips (ill-65)

This service enables you to retrieve ILL lending requests, produce a report, and print a separate slip for each retrieval request. The service also enables you to update the status of Located, Multiple Located and New requests upon printing slips. Requests that are Located (LOC) are updated to Located and Printed (LPR), requests that are Multiple Located (MLC) are updated to Multiple Located and Printed (MLP) and request that are in NEW status are updated to New and Printed (NEP).

7.3 US Copyright Services

7.3.1 Copyright Payment Report (ill-61)

This service performs the following two actions and produces an output report.

- **Action 1:** Assigns a common approval number to all borrowing requests which are filled and with a copyright status of 'Above the maximum number of free copies' (status code 20). An output report is produced showing the details of all retrieved requests.
- **Action 2:** Changes the copyright payment status of requests that are assigned to a common approval number. An output report is produced showing the details of all retrieved requests.

For more information: refer to the 'US Copyright' chapter in the *System Librarian's Guide - Integrated ILL*.

7.3.2 Copyright Statistics Report (ill-62)

The Copyright Statistics Report detects highly requested titles, and therefore should be candidates for acquisition.

It runs over all filled requests of the ILL Unit or Group (in case the unit is part of a group) with a copyright status of either '10 - Under the maximum number of free copies' or '20 - Above the maximum number of free copies' and produces a report that shows the number of requests per title and the number of different requesters (patrons) that have requested each title (template file name: copyright-statistic-report.xml).

For more information: refer to the 'US Copyright' chapter in the *System Librarian's Guide - Integrated ILL*.

7.4 Archiving Services

7.4.1 Generate Borrowing History (ill-88)

This service enables the archiving of inactive ILL Borrowing requests. Inactive requests are request whose status is one of the following: Cancelled, Closed, Deleted, Expired, or Unfilled.

This service allows running the procedures for all 'inactive' requests or for specific statuses. In addition, the users have to fill in the 'Status Date Before' parameters so

that only requests whose status date is before the quoted date (inclusive) are collected by the service.

ILL Requests which are handled by the Generate Borrowing History (ill-88) service are considered 'history records'. All request related records remain attached to the requests so that all request information is kept (BIB records, request to suppliers, copyright records, request logs, etc.).

If a request has an attached open cash transaction (cash transactions that are not Closed or Waived), it will not be archived by ill-88 services. The history requests are retained in their original ILL Library (XXX40).

For each request that is archived a request log entry will be updated that records the archive action.

For more details, see the 'ILL History Procedure' chapter in this document.

7.4.2 Generate Lending History (ill-89)

This service enables the archiving of inactive ILL Lending requests. Inactive requests are requests whose status is one of the following: Cancelled by Requester, Closed, Deleted, Expired, or Answer Unfilled.

This service allows running the procedures for all 'inactive' requests or for specific statuses. In addition, the users have to fill in the 'Status Date Before' parameters so that only requests whose status date is before the quoted date (inclusive) are collected by the service.

ILL Requests that are handled by the Generate Lending History (ill-89) service are considered 'history records'. All request related records remain attached to the requests so that all request information is kept (BIB records, request logs, etc.).

If a request has an attached open cash transaction (cash transactions that are not Closed or Waived), it will not be archived by ill-89 services. The history requests are retained in their original ILL Library (XXX40).

Each request that is archived will be updated with a request log that records the archive action.

For more details, see the 'ILL History Procedure' chapter in this document.

7.4.3 Archive ILLSV Documents (ill-72)

This service enables the archiving of ILLSV documents. The archived records are written into the archive directory at ILLSV library's root. A new directory is created in the archive directory with a name that is made up of the 'From' and 'To' dates in the following manner: {From Date}-{To Date}-{PID}. All archived records are written into that directory.

7.4.4 Patron Link Removal (ill-70)

This service erases patron details (for example, ID, name, address, e-mail, and so on) from ILL incoming and outgoing request records (current and historical records) to ensure patron confidentiality. The patron information is replaced with "SCBYYYYMMDD" where the last 8 characters are the service's execution date.

The service handles requests with the following statuses: Canceled, Closed, Expired and Deleted.

The ill-70 service produces a report (patron-removal-ids) which lists all requests where patron details have been erased.

7.5 General Services

This section refers only to General services that are directly related to ILL.

7.5.1 Build Word Indexes for a Record (manage-111)

This service creates keywords from various fields of the following Oracle tables: Vendor (Z70), Vendor Address (Z72), Global Patron (Z303), Patron Address (Z304), Reading Room (Z310), Budget (Z76) and **ILL Partners (Z700)**. The keyword index that is created enables the user to search for records in the GUI by keywords

7.5.2 Synchronize patrons' data with ILL partners' data (ill-77)

This function enables you to create or update patrons' data from ILL partners' data. Included are both name and address information. Each ILL partner (internal ILL unit and external partners) that is used as an ILL requester must have an equivalent patron record in your system. For easy maintenance, you can use this job in order to change data in the partner record only and then synchronize the information with the matching patron record. This requires corresponding identifiers in both records: The partner code (Z700-INTERNAL-CODE) must be identical with either the user ID (Z303-ID) or the user BARCODE (Z308-KEY-DATA where Z308-KEY-TYPE=01). In the case of a match, no comparison takes place; the partner data always overrides the patron user data.

If a partner record does not have a corresponding patron record, it will be created.

7.5.3 Load Potential Supplier Default (ill-52)

This service enables you to load the potential supplier default (Z701) based on table configuration: tab_z701. tab_z701 can be located either in the ILL Library tab directory (./xxx40/tab/tab_z701) OR in the alephe tab directory (./alephe/tab/tab_z701).

In case there is no tab_z701 file in the ILL Library path (or it is empty), the system will use the wide-default table of the alephe path.

The load will be performed only if the 'Potential Supplier List' of the ILL Unit is empty; Otherwise, you will be prompted by a block message: "Service cannot be run. Potential supplier list already exists.

For more information, refer to the Loading a Default Roster of Suppliers chapter in the System Librarian's Guide - Integrated ILL.

Appendix A

Borrowing Request Statuses that have a Corresponding ISO/ILL Protocol State

The Summary mode of the **BORROWING** tab's Navigation pane displays the statuses for outgoing ILL requests, in varying stages of completion. Following is a brief description of the statuses.

Code	Description	Corresponding ISO/ILL Protocol State	Significance
NEW	New	IDLE	This is a new request. Potential suppliers have not yet been identified.
NEM	New – Staff Review	IDLE	This is a new request that includes data in the Note field. Potential suppliers have not yet been identified.
WAP	Waiting for process	IDLE	Request has an active Potential Supplier, but the request has not yet been sent.
LOF	Locate failed	IDLE	The LOCATE action did not succeed in identifying potential suppliers.
WPR	Waiting patron response	PENDING	The request has already been sent to supplier but additional information has been required by the supplier. Letter sent to patron to clarify the issue.
SV	Sent to Supplier	PENDING	The request has been sent to a Supplier; no subsequent response has been registered.
SHP	Shipped	SHIPPED	The Supplier has sent a SHIPPED message.
RTY	Retry	NOT-SUPPLIED	The Supplier has sent a RETRY message.
UNF	Unfilled	NOT-SUPPLIED	The Supplier has sent a message declaring that he cannot supply (ISO ILL-ANSWER/Unfilled message).

Code	Description	Corresponding ISO/ILL Protocol State	Significance
WSP	Will be Supplied	PENDING	The Supplier has sent a message declaring that he will supply (ISO ILL-ANSWER/Will Supply message).
CRP	Conditional Reply	CONDITIONAL	The Supplier has sent a message declaring that he can supply under certain conditions (ISO ILL-ANSWER/Conditional message).
HPL	Hold Placed	PENDING	The Supplier has sent a message declaring that he has placed a hold in order to supply (ISO ILL-ANSWER/Hold Placed message).
EST	Estimate Reply	NOT-SUPPLIED	The Supplier has sent a message declaring that he can supply under certain conditions (ISO ILL-ANSWER/Estimate message).
LON	Loaned	RECEIVED	ILL staff has performed a RECEIVED action on the request.
LOP	Loaned to Patron	RECEIVED	ILL staff has performed a RECEIVED action on the request. Item has been loaned to patron.
RT	Returned	RETURNED	ILL staff has performed a RETURNED action on the request.
CLS	Closed	RETURNED	The Supplier has sent a message declaring that he has received the returned material (ISO ILL-ANSWER/CHECKED-IN message).
WRN	Waiting for Renewal Reply	RENEW/PENDING	ILL staff has performed a RENEW action on the request (that is, a renew message is sent to the supplier).

Code	Description	Corresponding ISO/ILL Protocol State	Significance
RNR	Renewal – Rejected	RECEIVED	The Supplier has sent a message declaring that the loan cannot be renewed (ISO ILL-RENEW-ANSWER/No message).
RNA	Renewal – Accepted	RECEIVED	The Supplier has sent a message declaring that the loan can be renewed (ISO ILL-RENEW-ANSWER/Yes message).
LST	Lost	LOST	ILL staff has performed a LOST action on the request
DMG	Damaged	None applicable	ILL staff has performed a DAMAGED action on the request.
WCR	Waiting for Cancel Reply	CANCEL-PENDING	ILL staff has performed a CANCEL action on a request that was sent to a Supplier, and is awaiting reply from the Supplier.
CA	Canceled	CANCELED	The Supplier has sent a message declaring that the loan can be canceled (ISO ILL-CANCEL-REPLY/Yes message).
RCL	Recalled	RECALL	The Supplier has sent a message requesting that the material be recalled (ISO ILL-RECALL message).
OVD	Overdue	OVERDUE	The Supplier has sent an OVERDUE message.
EXP	Expired	NOT-SUPPLIED	The Supplier has sent an EXPIRED message.
DEL	Deleted	NOT-SUPPLIED	Request has been deleted by ILL staff.

Appendix B

Lending library request statuses

The Summary mode of the **LENDING** tab's Navigation pane displays the statuses for incoming ILL requests, in varying stages of completion. Following is a brief description of the statuses.

Code	Description	Corresponding ISO/ILL Protocol State	Significance
NEW	New	IN-PROCESS	A new request. (LOCATE not yet performed.)
NEM	New – Staff Review	IN-PROCESS	A new request. Patron fills the note field before sending request to supplier. LOCATE is not yet activated. Automatic locate is disabled.
LOC	Located	IN-PROCESS	A request on which LOCATE was performed (automatically or manually), and a match was found.
LPR	Located and Printed	IN-PROCESS	A request on which LOCATE was performed (automatically or manually), a match was found, and a pick-up slip was printed (by automatic library processes; using the ill-50 service; manually).
MLC	Multiple Located	IN-PROCESS	A request on which LOCATE was performed (automatically or manually), and more than one match was found.
NEP	New - Printed	IN-PROCESS	A new request for which an information slip has already been printed (by the ill-50 service or manually). LOCATE is not yet active. Automatic locate is disabled.

Code	Description	Corresponding ISO/ILL Protocol State	Significance
MLP	Multiple Located - Printed	IN-PROCESS	A request on which LOCATE was performed (automatically or manually), more than one match was found and for which an information slip has already been printed (either by automatic ILL library process, ill-50 service or manually).
MED	Mediated	IN-PROCESS	A request on which LOCATE was performed (automatically or manually), and a match was not found.
REF	Referred	IN-PROCESS	A request which was not located, and was subsequently referred by the ILL Unit to a different supplier, as a borrowing request. This is a special case in which the lending library acts as a clearinghouse; it supplies material from its 'home' site and forwards unanswerable requests to other sites.
SL	Sent on loan	SHIPPED	ILL staff has performed a SHIPPED action on the request, having sent a returnable item. The item has been loaned to the requesting library.
SC	Sent as copy	SHIPPED	ILL staff has performed a SHIPPED action on the request, having sent a non-returnable item.
CAN	Answer Conditional	CONDITIONAL	A message has been sent to requester stating that the material is available subject to conditions (ISO ILL-ANSWER/ Conditional message).
ART	Answer Retry	NOT-SUPPLIED	A message has been sent to requester stating that the material is not currently available and the requester should try again at a later date (ISO ILL-ANSWER/Retry message).

Code	Description	Corresponding ISO/ILL Protocol State	Significance
AUF	Answer Unfilled	NOT-SUPPLIED	A message has been sent to the requester stating that the material cannot be supplied (ISO ILL-ANSWER/Unfilled message).
ALC	Answer Locations	NOT-SUPPLIED	Local staff has sent an ISO ILL-ANSWER /Location message.
AWS	Answer Will-Supply	IN-PROCESS	A message has been sent to the requester stating that the material will be supplied (ISO ILL-ANSWER/Will supply message).
AHP	Answer Hold-Placed	IN-PROCESS	A message has been sent to the requester stating that hold has been placed so that the material will be supplied (ISO ILL-ANSWER/Hold-placed message).
AES	Answer Estimate	NOT-SUPPLIED	A message has been sent to the requester stating that there is a cost involved in supplying the material (ISO ILL-ANSWER/Estimated).
RCV	Received by Borrower	SHIPPED	The Borrower (requester) has sent a RECEIVED message.
RT	Return	SHIPPED	The Borrower (requester) has sent a RETURNED message, meaning that he has sent the material.
CLS	Closed	CHECKED-IN	ILL staff has received the material that was returned, and has performed a CHECK-IN action on the request.
LST	Lost	LOST	The borrower (requester) has sent a LOST message.
DMG	Damaged	None applicable	The borrower (requester) has sent a DAMAGED message.
CBR	Canceled by Borrower	CANCEL-PENDING	The borrower (requester) has sent a CANCEL message.
CRA	Conditional-Reply accepted	Conditional-Reply accepted	The borrower has sent a Conditional Reply – accepted message.
RCL	Recall	RECALL	Local staff has performed a RECALL action on the request.

Code	Description	Corresponding ISO/ILL Protocol State	Significance
OVD	Overdue	OVERDUE	Local staff has performed an OVERDUE action on the request.
EXP	Expired	NOT- SUPPLIED	EXPIRED message sent to borrower.